

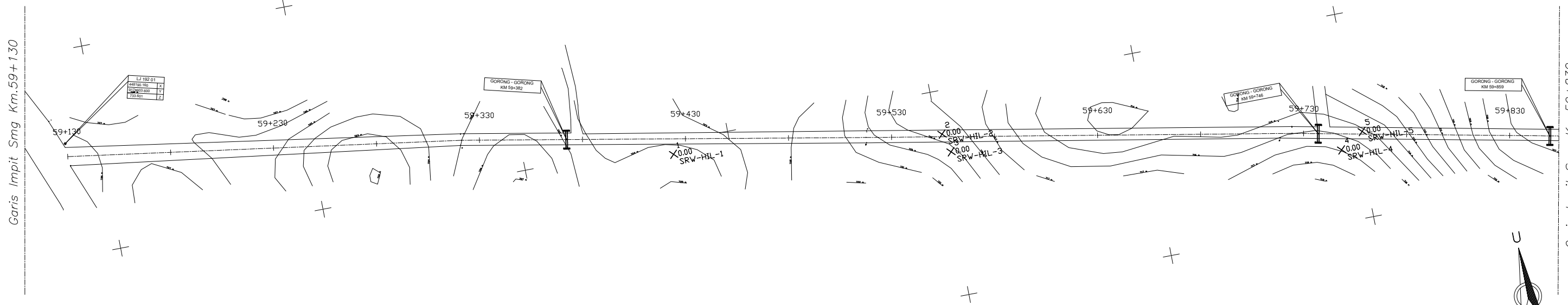

SMG KM. 59+130 S/D KM. 59+830

GAMBAR SITUASI DAN POTONGAN

ALINYEMEN HORIZONTAL
SKALA LEBAR 1 : 2000 SKALA MEMANJANG 1 : 2000



ALINYEMEN VERTIKAL
SKALA TEGAK 1 : 500
SKALA MEMANJANG 1 : 2000

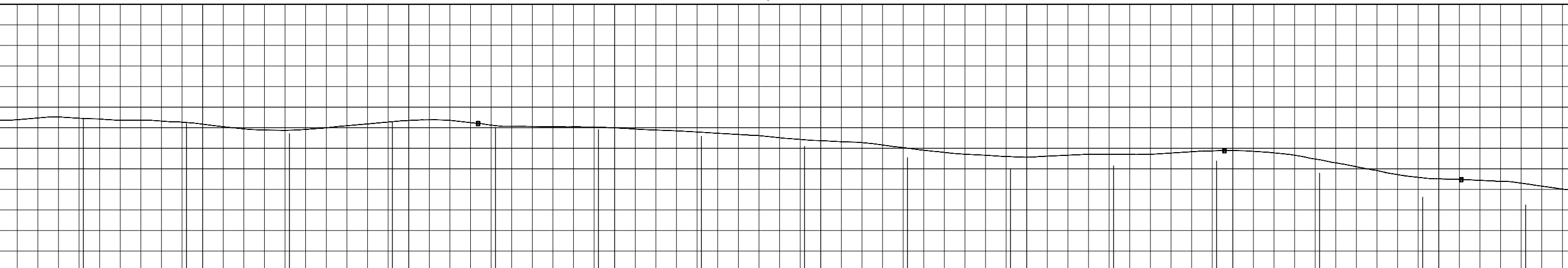

KETINGGIAN
MUKA
AS JALAN

726.00	726.53	725.26	722.75	725.52	724.25	723.74	722.08	719.66	716.94	714.20	714.94	716.09	713.17	707.32	705.40
--------	--------	--------	--------	--------	--------	--------	--------	--------	--------	--------	--------	--------	--------	--------	--------

SMG KM

59+130	59+230	59+330	59+430	59+530	59+630	59+730	59+830
--------	--------	--------	--------	--------	--------	--------	--------

PENAMPANG MELINTANG
SKALA TEGAK 1 : 500 MEMANJANG 1 : 500

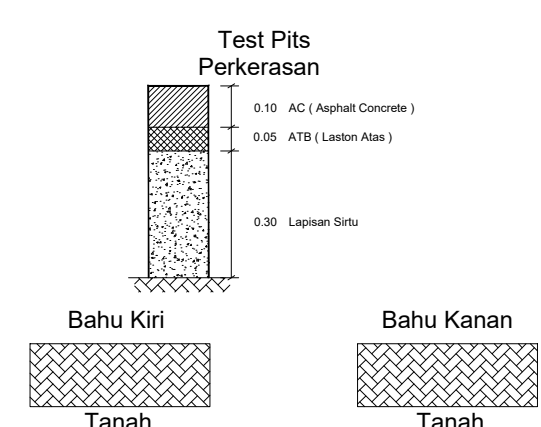
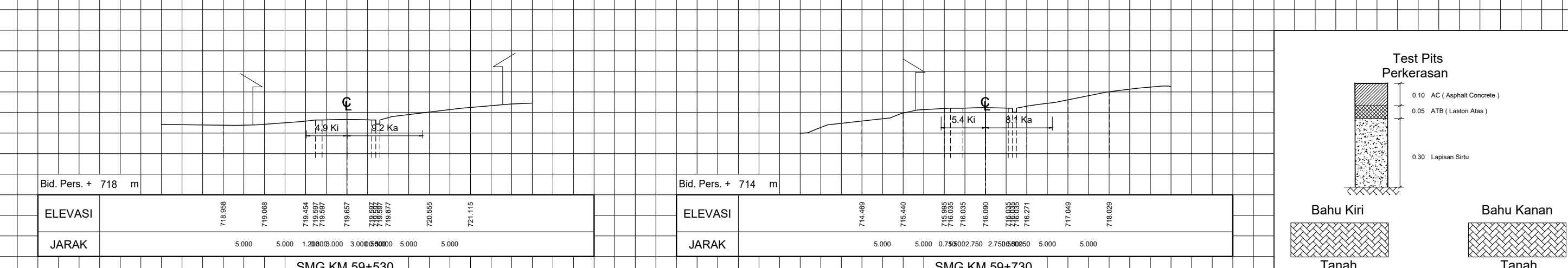

SMG KM.59+530		SMG KM.59+730	
ELEVASI	718.958, 719.068, 719.454, 719.597, 719.657, 718.567, 719.877, 720.555, 721.115	ELEVASI	714.469, 715.440, 716.095, 716.035, 716.090, 716.095, 716.271, 717.049, 718.029
JARAK	5.000, 5.000, 1.200, 3.000, 3.000, 5.000, 5.000	JARAK	5.000, 5.000, 0.750, 0.002, 0.750, 2.750, 0.002, 5.000, 5.000

(HITAM) GAMBAR ASLI (BIRU) PEMUTAKHIRAN I (COKLAT) PEMUTAKHIRAN II (HIJAU) PEMUTAKHIRAN III (UNGU) PEMUTAKHIRAN IV

KETERANGAN GAMBAR DAPAT DILIHAT PADA LEMBAR LEGENDA



SMG KM. 59+830 S/D KM. 60+530

GAMBAR SITUASI DAN POTONGAN

ALINYEMEN HORIZONTAL
 SKALA LEBAR 1 : 2000 SKALA MEMANJANG 1 : 2000

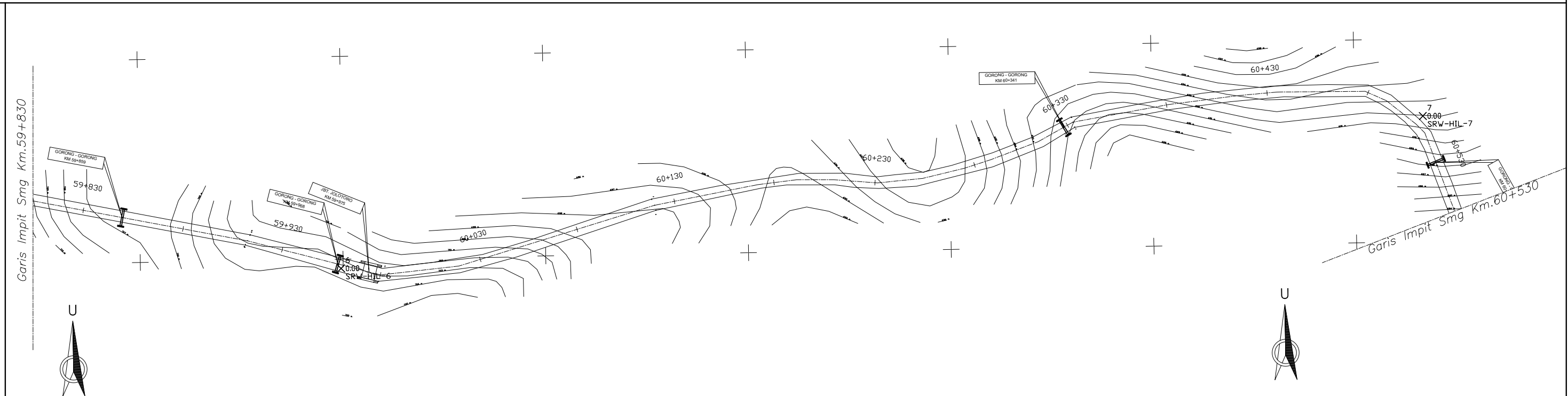

ALINYEMEN VERTIKAL
 SKALA TEGAK 1 : 500
 SKALA MEMANJANG 1 : 2000

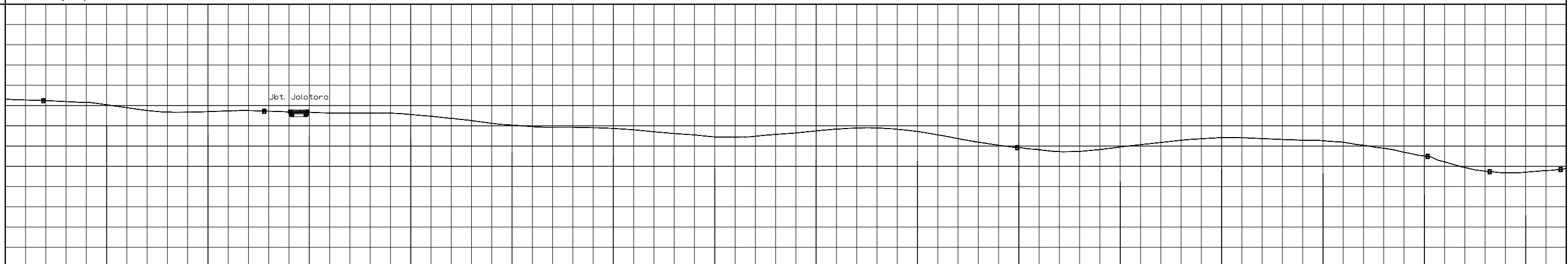

KETINGGIAN
 MUKA
 AS JALAN

707.32	705.40	703.13	702.93	702.16	698.70	697.59	694.79	696.79	696.57	691.25	691.51	694.56	693.55	688.33	683.20
--------	--------	--------	--------	--------	--------	--------	--------	--------	--------	--------	--------	--------	--------	--------	--------

SMG KM

59+830	59+930	60+030	60+130	60+230	60+330	60+430	60+530
--------	--------	--------	--------	--------	--------	--------	--------

PENAMPANG MELINTANG
 SKALA TEGAK 1 : 500 MEMANJANG 1 : 500

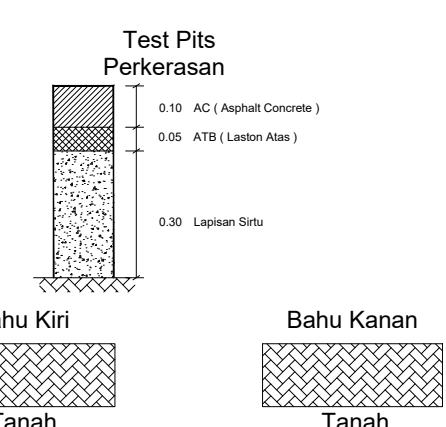
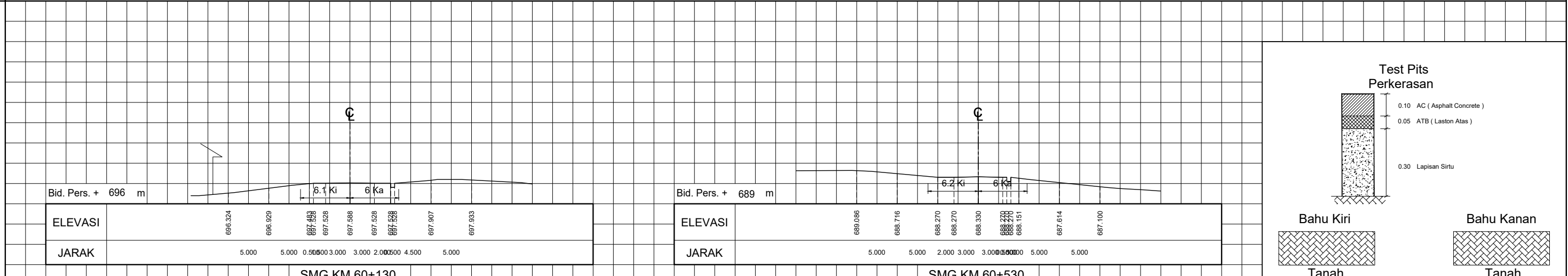

SMG KM.60+130 SMG KM.60+530

ELEVASI	696.324	696.929	697.458	697.528	697.588	697.528	697.528	697.907	697.933
JARAK	5.000	5.000	0.500	3.000	3.000	2.000	0.500	4.500	5.000

ELEVASI	689.086	688.716	688.270	688.270	688.330	688.270	688.151	687.614	687.100
JARAK	5.000	5.000	2.000	3.000	3.000	1.500	5.000	5.000	

(HITAM) GAMBAR ASLI (BIRU) PEMUTAKHIRAN I (COKLAT) PEMUTAKHIRAN II (HIJAU) PEMUTAKHIRAN III (UNGU) PEMUTAKHIRAN IV

KETERANGAN GAMBAR DAPAT DILIHAT PADA LEMBAR LEGENDA



SMG KM. 61+230 S/D KM. 61+930

GAMBAR SITUASI DAN POTONGAN

ALINYEMEN HORIZONTAL
 SKALA LEBAR 1 : 2000 SKALA MEMANJANG 1 : 2000

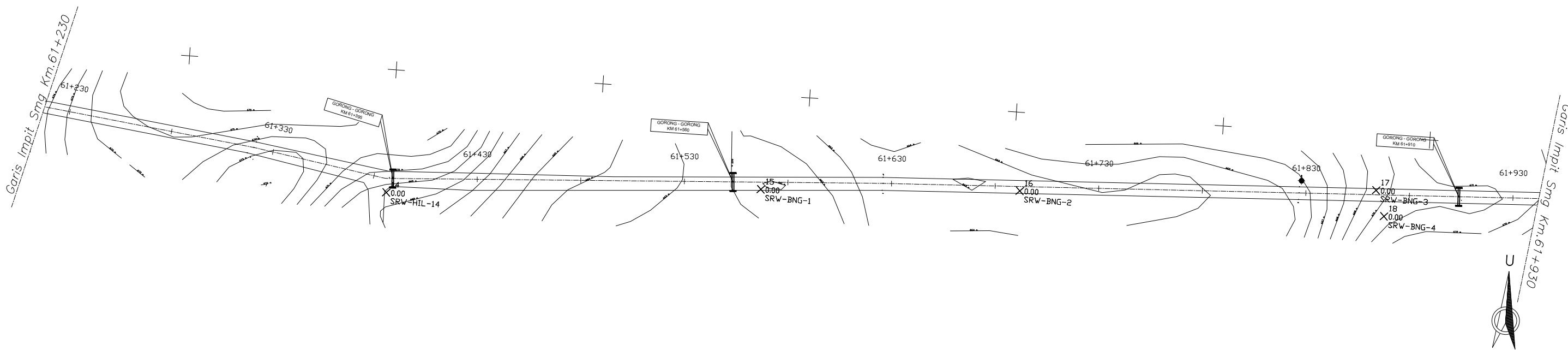

ALINYEMEN VERTIKAL
 SKALA TEGAK 1 : 500
 SKALA MEMANJANG 1 : 2000

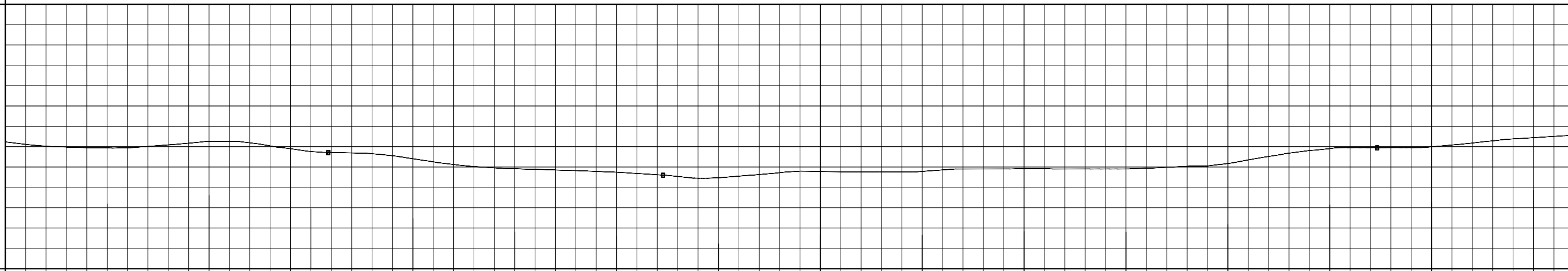

KETINGGIAN MUKA AS JALAN

672.92	670.90	673.05	669.73	667.35	664.07	662.94	661.13	663.19	663.24	664.13	664.00	665.81	670.69	671.28	674.26
--------	--------	--------	--------	--------	--------	--------	--------	--------	--------	--------	--------	--------	--------	--------	--------

SMG KM

61+230	61+330	61+430	61+530	61+630	61+730	61+830	61+930
--------	--------	--------	--------	--------	--------	--------	--------

PENAMPANG MELINTANG
 SKALA TEGAK 1 : 500 MEMANJANG 1 : 500

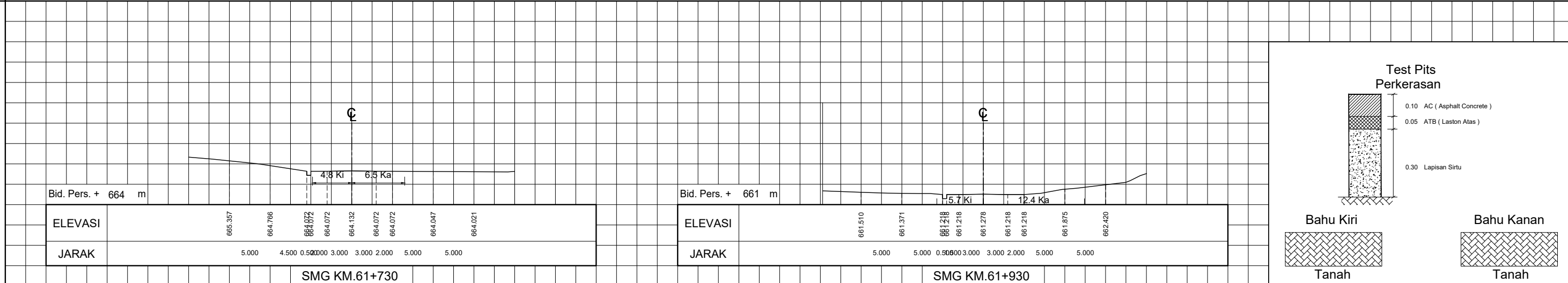

(HITAM) GAMBAR ASLI (BIRU) PEMUTAKHIRAN I (COKLAT) PEMUTAKHIRAN II (HIJAU) PEMUTAKHIRAN III (UNGU) PEMUTAKHIRAN IV

KETERANGAN GAMBAR DAPAT DILIHAT PADA LEMBAR LEGENDA



SMG KM. 61+930 S/D KM. 62+630

GAMBAR SITUASI DAN POTONGAN

ALINYEMEN HORIZONTAL
SKALA LEBAR 1 : 2000 SKALA MEMANJANG 1 : 2000

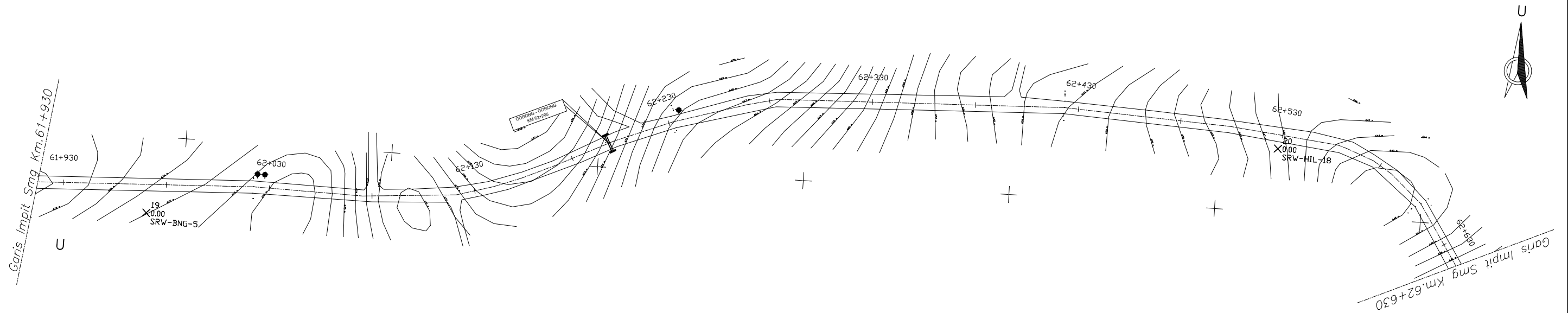

ALINYEMEN VERTIKAL
SKALA TEGAK 1 : 500
SKALA MEMANJANG 1 : 2000

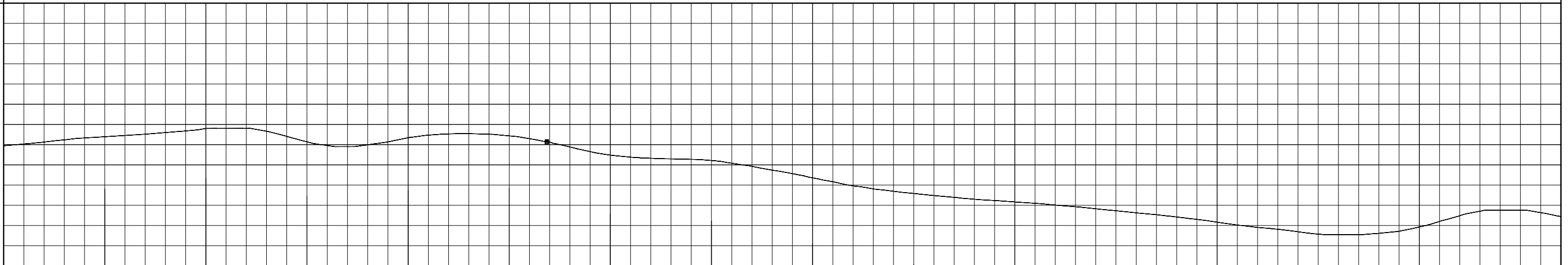

KETINGGIAN
MUKA
AS JALAN

671.28	674.26	676.97	672.60	673.90	674.54	668.21	666.42	660.70	655.55	652.76	649.85	646.07	642.16	644.50	650.00
--------	--------	--------	--------	--------	--------	--------	--------	--------	--------	--------	--------	--------	--------	--------	--------

SMG
KM

61+930	62+030	62+130	62+230	62+330	62+430	62+530	62+630
--------	--------	--------	--------	--------	--------	--------	--------

PENAMPANG MELINTANG
SKALA TEGAK 1 : 500 MEMANJANG 1 : 500

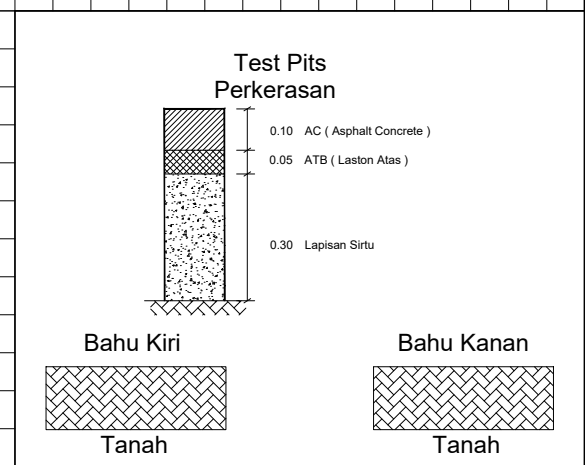
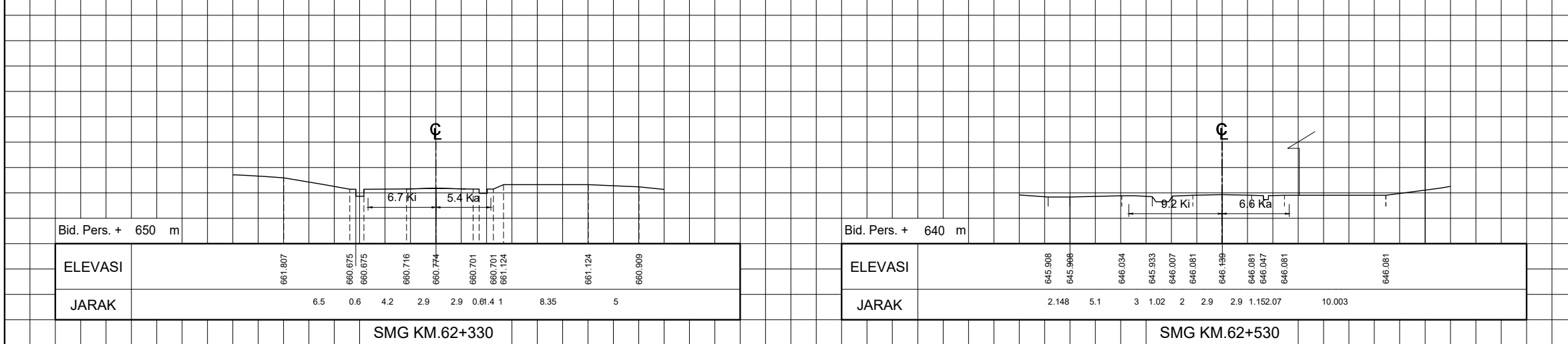

(HITAM) GAMBAR ASLI (BIRU) PEMUTAKHIRAN I (COKLAT) PEMUTAKHIRAN II (HIJAU) PEMUTAKHIRAN III (UNGU) PEMUTAKHIRAN IV

KETERANGAN GAMBAR DAPAT DILIHAT PADA LEMBAR LEGENDA



SMG KM. 62+630 S/D KM. 63+330

GAMBAR SITUASI DAN POTONGAN

ALINYEMEN HORIZONTAL
SKALA LEBAR 1 : 2000 SKALA MEMANJANG 1 : 2000

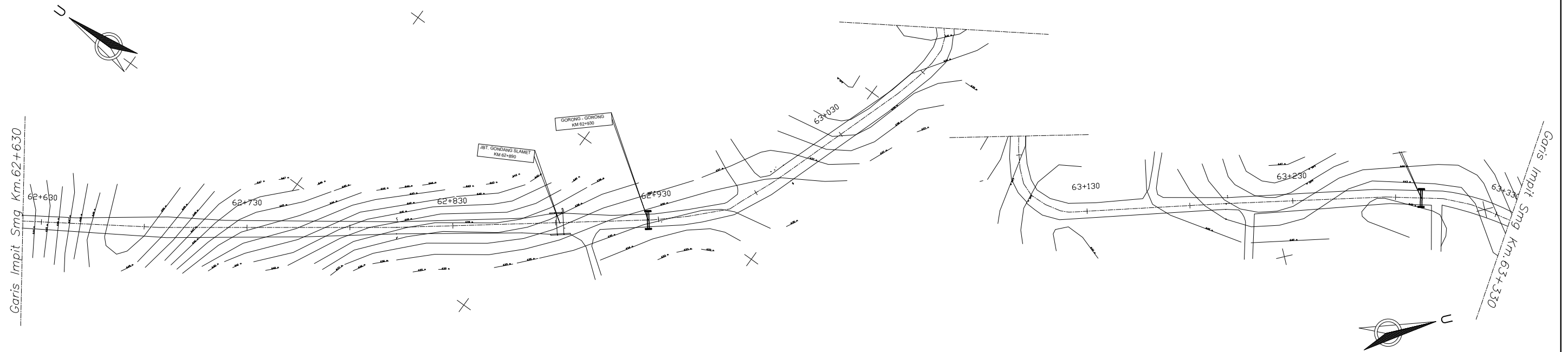

ALINYEMEN VERTIKAL
SKALA TEGAK 1 : 500
SKALA MEMANJANG 1 : 2000

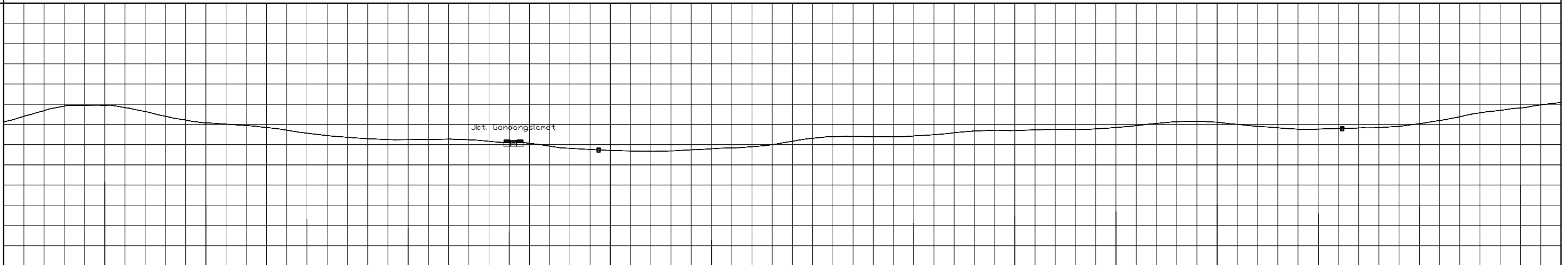

KETINGGIAN
MUKA
AS JALAN

644.50	650.00	644.19	640.80	638.66	637.50	635.10	635.63	639.10	639.86	641.68	642.66	644.39	642.14	643.93	645.10
--------	--------	--------	--------	--------	--------	--------	--------	--------	--------	--------	--------	--------	--------	--------	--------

SMG
KM

62+630	62+730	62+830	62+930	63+030	63+130	63+230	63+330
--------	--------	--------	--------	--------	--------	--------	--------

PENAMPANG MELINTANG
SKALA TEGAK 1 : 500 MEMANJANG 1 : 500

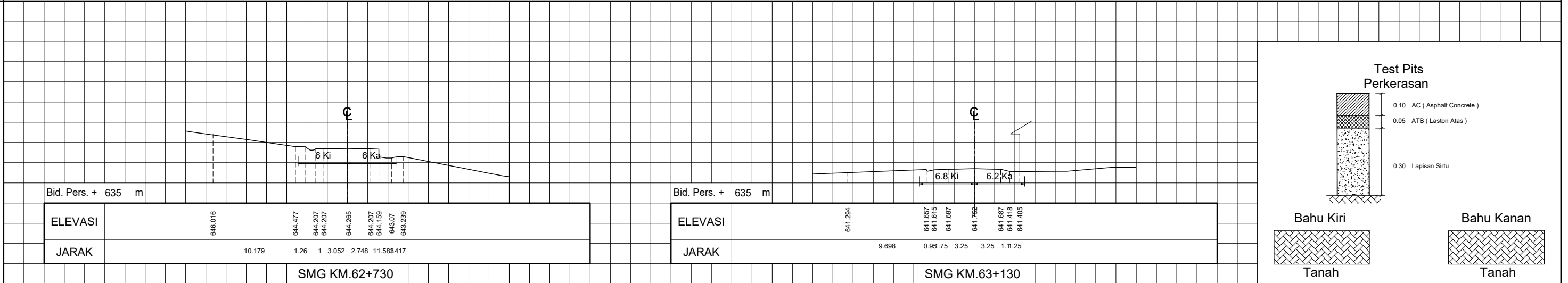

(HITAM) GAMBAR ASLI (BIRU) PEMUTAKHIRAN I (COKLAT) PEMUTAKHIRAN II (HIJAU) PEMUTAKHIRAN III (UNGU) PEMUTAKHIRAN IV

KETERANGAN GAMBAR DAPAT DILIHAT PADA LEMBAR LEGENDA



SMG KM. 63+330 S/D KM. 64+030

GAMBAR SITUASI DAN POTONGAN

ALINYEMEN HORIZONTAL
 SKALA LEBAR 1 : 2000 SKALA MEMANJANG 1 : 2000

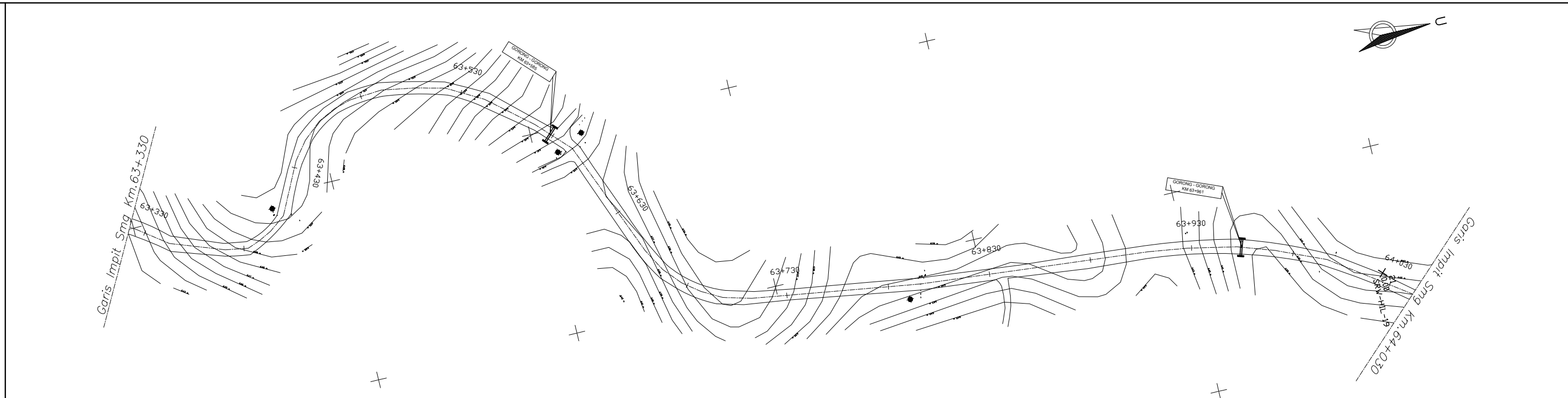

ALINYEMEN VERTIKAL
 SKALA TEGAK 1 : 500
 SKALA MEMANJANG 1 : 2000

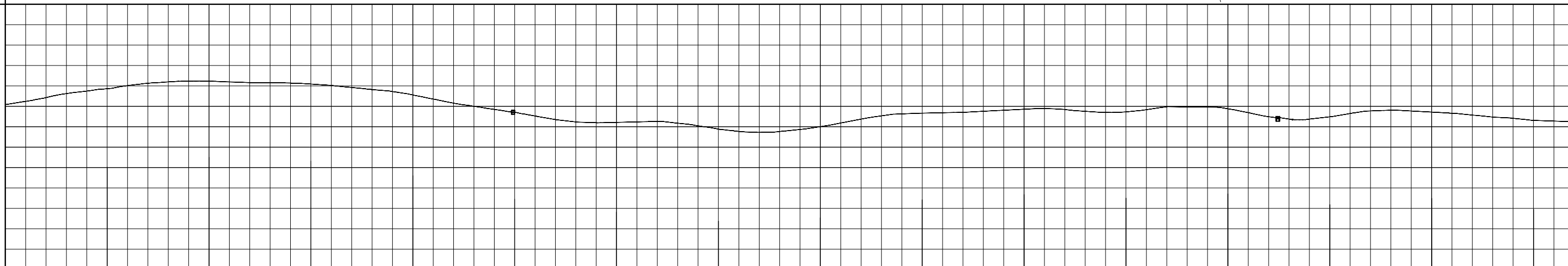

KETINGGIAN
 MUKA
 AS JALAN

643.93	649.10	651.54	650.63	647.06	641.30	638.11	635.90	636.72	641.13	642.40	641.53	642.55	639.93	641.46	638.77
--------	--------	--------	--------	--------	--------	--------	--------	--------	--------	--------	--------	--------	--------	--------	--------

SMG
 KM

63+330	63+430	63+530	63+630	63+730	63+830	63+930	64+030
--------	--------	--------	--------	--------	--------	--------	--------

PENAMPANG MELINTANG
 SKALA TEGAK 1 : 500 MEMANJANG 1 : 500

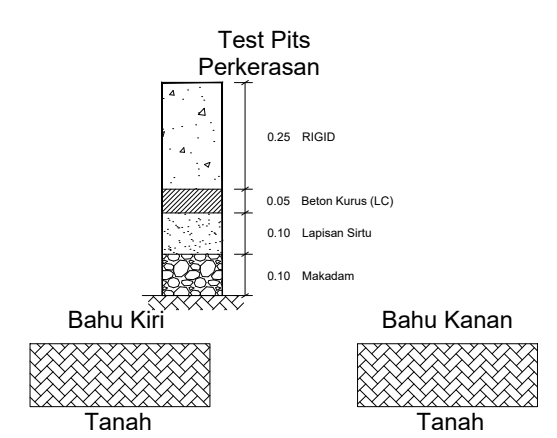
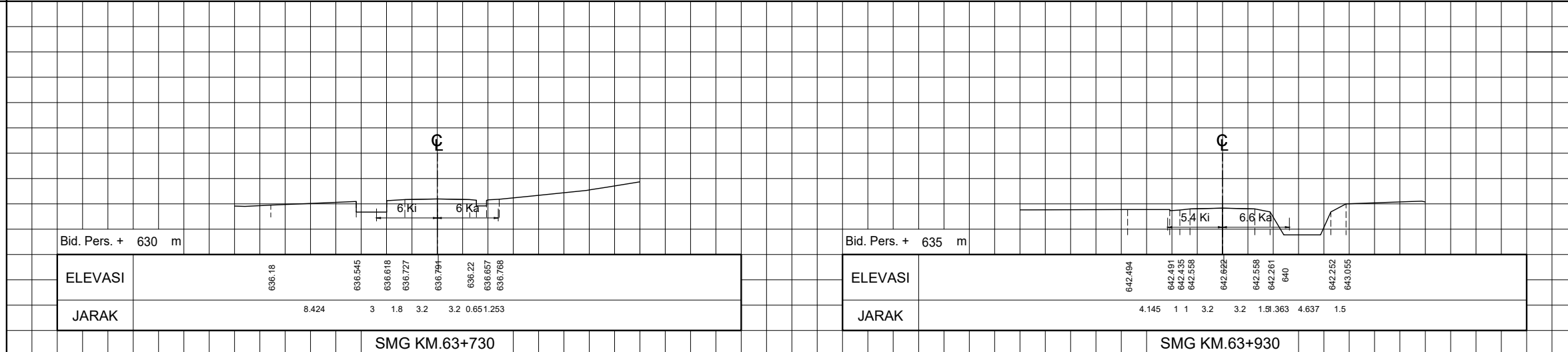

(HITAM) GAMBAR ASLI (BIRU) PEMUTAKHIRAN I (COKLAT) PEMUTAKHIRAN II (HIJAU) PEMUTAKHIRAN III (UNGU) PEMUTAKHIRAN IV

KETERANGAN GAMBAR DAPAT DILIHAT PADA LEMBAR LEGENDA



SMG KM. 64+730 S/D KM. 65+430

GAMBAR SITUASI DAN POTONGAN

ALINYEMEN HORIZONTAL
SKALA LEBAR 1 : 2000 SKALA MEMANJANG 1 : 2000



ALINYEMEN VERTIKAL
SKALA TEGAK 1 : 500
SKALA MEMANJANG 1 : 2000

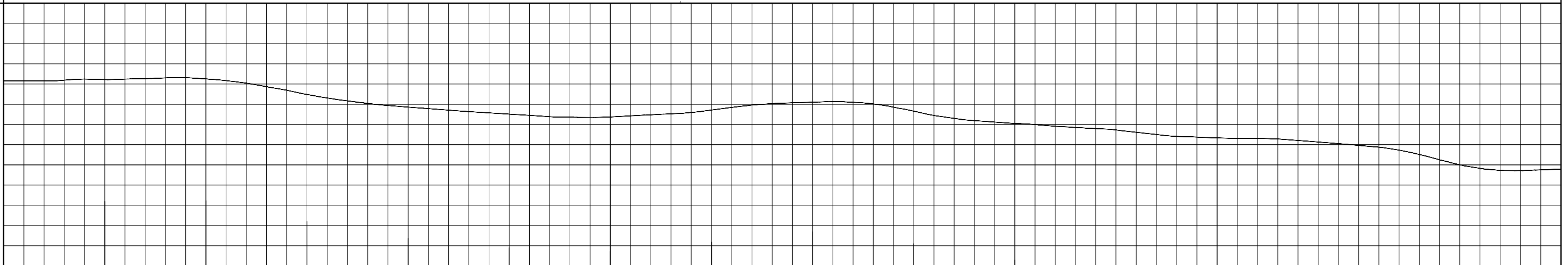

KETINGGIAN
MUKA
AS JALAN

605.00	605.39	605.61	600.48	596.32	594.00	593.07	595.35	597.93	594.96	590.95	588.78	586.16	584.81	580.68	575.39
--------	--------	--------	--------	--------	--------	--------	--------	--------	--------	--------	--------	--------	--------	--------	--------

SMG
KM

64+730	64+830	64+930	65+030	65+130	65+230	65+330	65+430
--------	--------	--------	--------	--------	--------	--------	--------

PENAMPANG MELINTANG
SKALA TEGAK 1 : 500 MEMANJANG 1 : 500

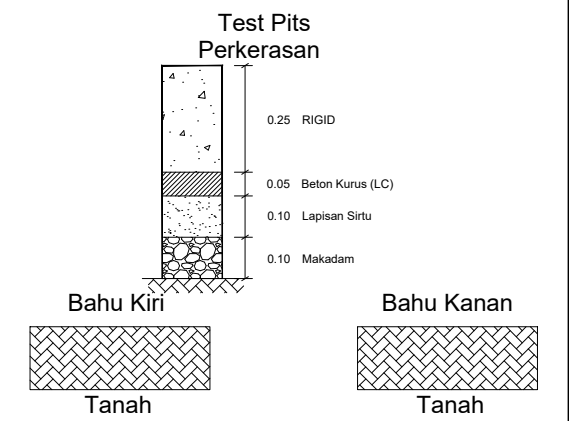
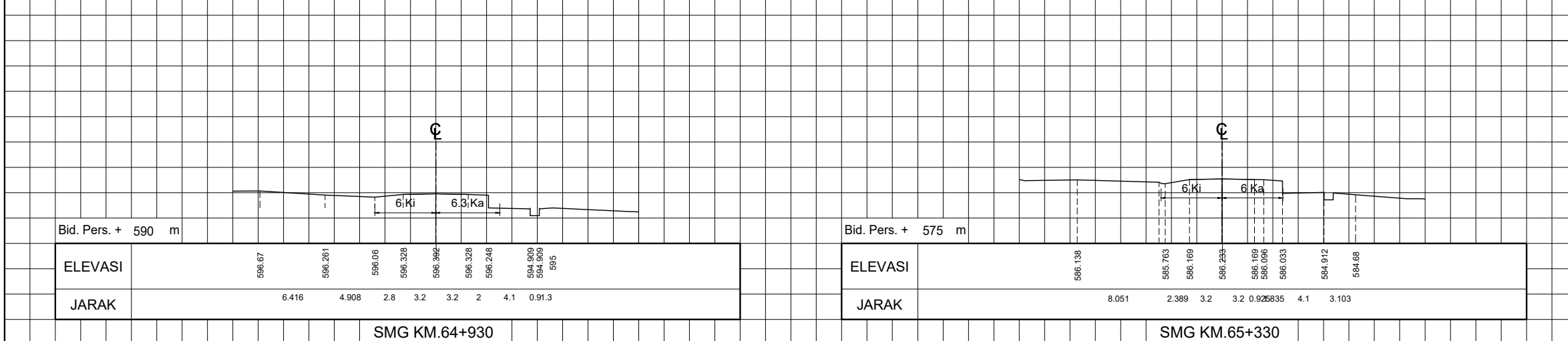

(HITAM) GAMBAR ASLI (BIRU) PEMUTAKHIRAN I (COKLAT) PEMUTAKHIRAN II (HIJAU) PEMUTAKHIRAN III (UNGU) PEMUTAKHIRAN IV

KETERANGAN GAMBAR DAPAT DILIHAT PADA LEMBAR LEGENDA



SMG KM. 65+430 S/D KM. 66+130

GAMBAR SITUASI DAN POTONGAN

ALINYEMEN HORIZONTAL
 SKALA LEBAR 1 : 2000 SKALA MEMANJANG 1 : 2000

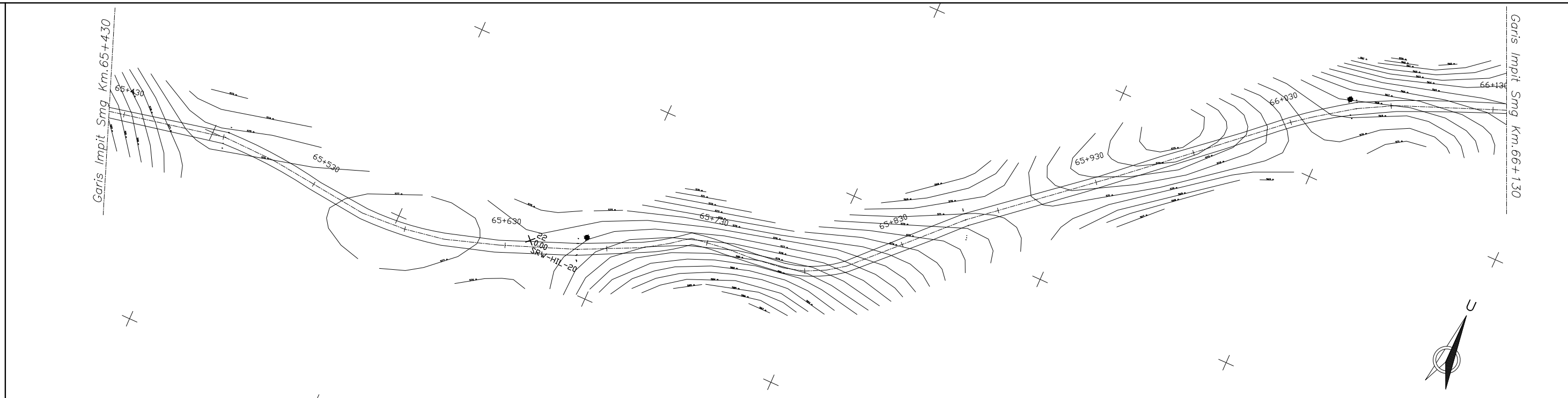

ALINYEMEN VERTIKAL
 SKALA TEGAK 1 : 500
 SKALA MEMANJANG 1 : 2000

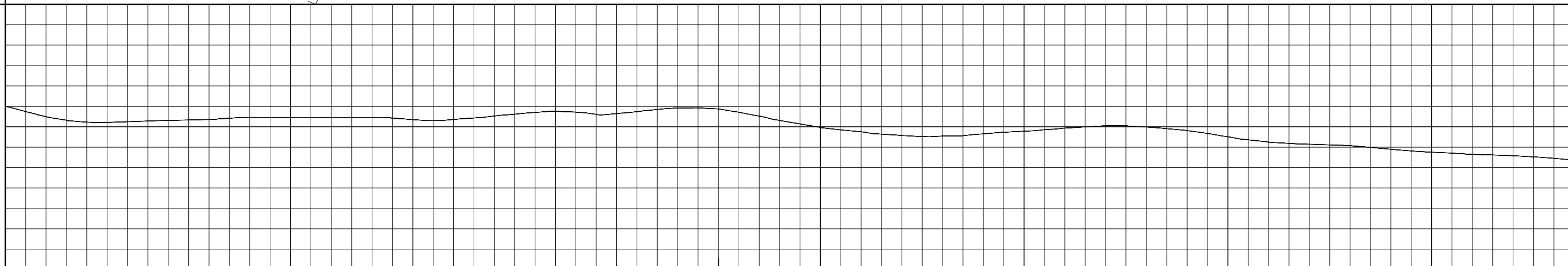

KETINGGIAN
 MUKA
 AS JALAN

580.68	575.39	576.35	577.00	576.31	578.07	578.28	579.78	573.74	570.82	572.51	574.23	570.70	568.04	565.68	564.14
--------	--------	--------	--------	--------	--------	--------	--------	--------	--------	--------	--------	--------	--------	--------	--------

SMG KM

65+430	65+530	65+630	65+730	65+830	65+930	66+030	66+130
--------	--------	--------	--------	--------	--------	--------	--------

PENAMPANG MELINTANG
 SKALA TEGAK 1 : 500 MEMANJANG 1 : 500

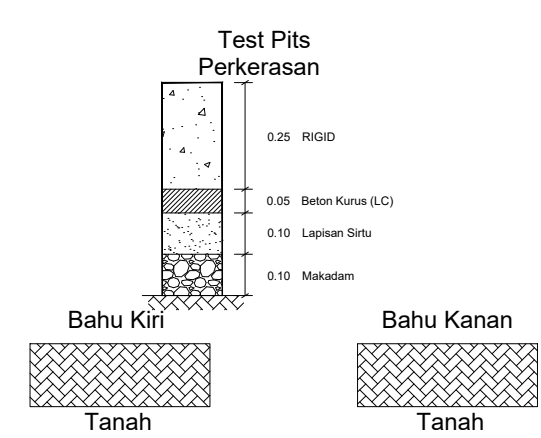
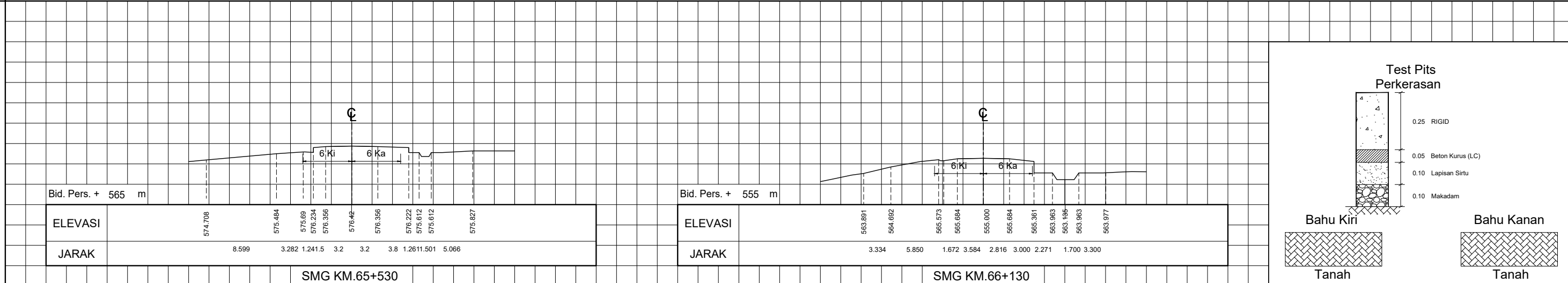

(HITAM) GAMBAR ASLI (BIRU) PEMUTAKHIRAN I (COKLAT) PEMUTAKHIRAN II (HIJAU) PEMUTAKHIRAN III (UNGU) PEMUTAKHIRAN IV

KETERANGAN GAMBAR DAPAT DILIHAT PADA LEMBAR LEGENDA



SMG KM. 67+530 S/D KM. 68+230

GAMBAR SITUASI DAN POTONGAN

ALINYEMEN HORIZONTAL
SKALA LEBAR 1 : 2000 SKALA MEMANJANG 1 : 2000

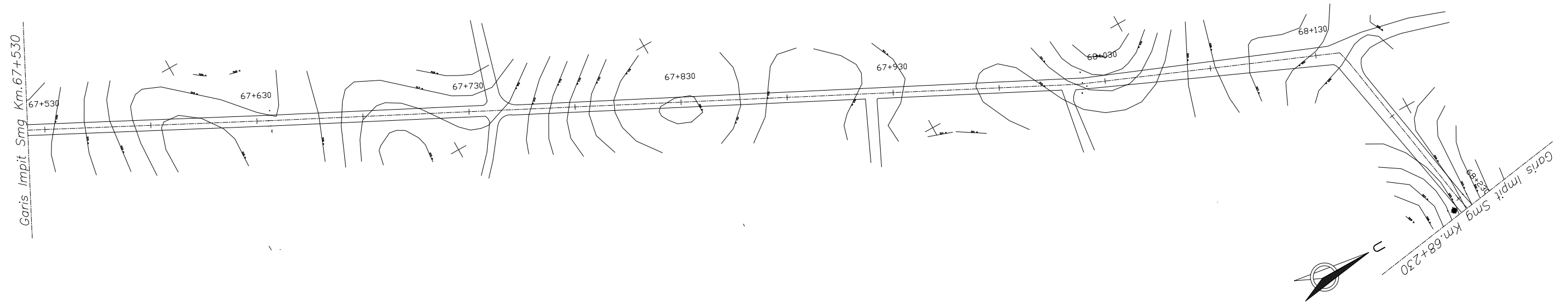

ALINYEMEN VERTIKAL
SKALA TEGAK 1 : 500
SKALA MEMANJANG 1 : 2000

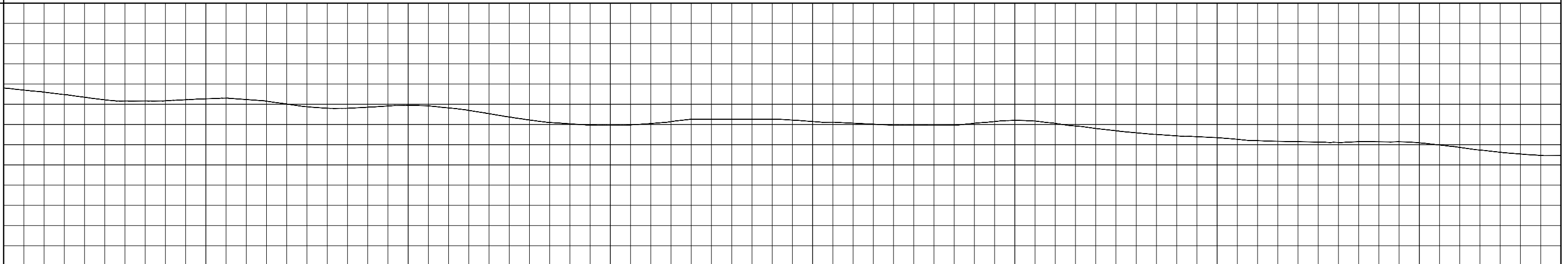

KETINGGIAN
MUKA
AS JALAN

522.30	518.37	518.72	516.08	516.52	512.71	510.00	512.00	511.23	510.00	511.61	508.17	505.89	504.45	504.21	500.50
--------	--------	--------	--------	--------	--------	--------	--------	--------	--------	--------	--------	--------	--------	--------	--------

SMG
KM

67+530	67+630	67+730	67+830	67+930	68+030	68+130	68+230
--------	--------	--------	--------	--------	--------	--------	--------

PENAMPANG MELINTANG
SKALA TEGAK 1 : 500 MEMANJANG 1 : 500

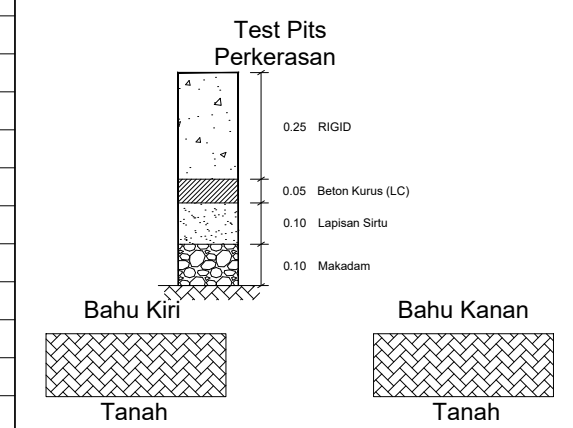
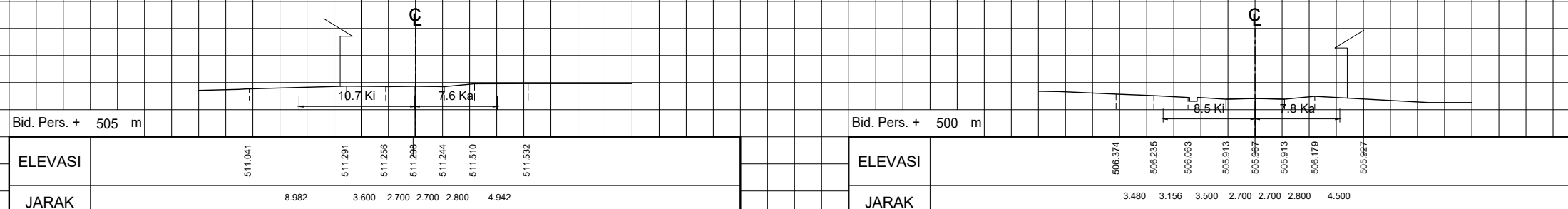

(HITAM) GAMBAR ASLI (BIRU) PEMUTAKHIRAN I (COKLAT) PEMUTAKHIRAN II (HIJAU) PEMUTAKHIRAN III (UNGU) PEMUTAKHIRAN IV

KETERANGAN GAMBAR DAPAT DILIHAT PADA LEMBAR LEGENDA



SMG KM. 68+230 S/D KM. 68+930

GAMBAR SITUASI DAN POTONGAN

ALINYEMEN HORIZONTAL
 SKALA LEBAR 1 : 2000 SKALA MEMANJANG 1 : 2000

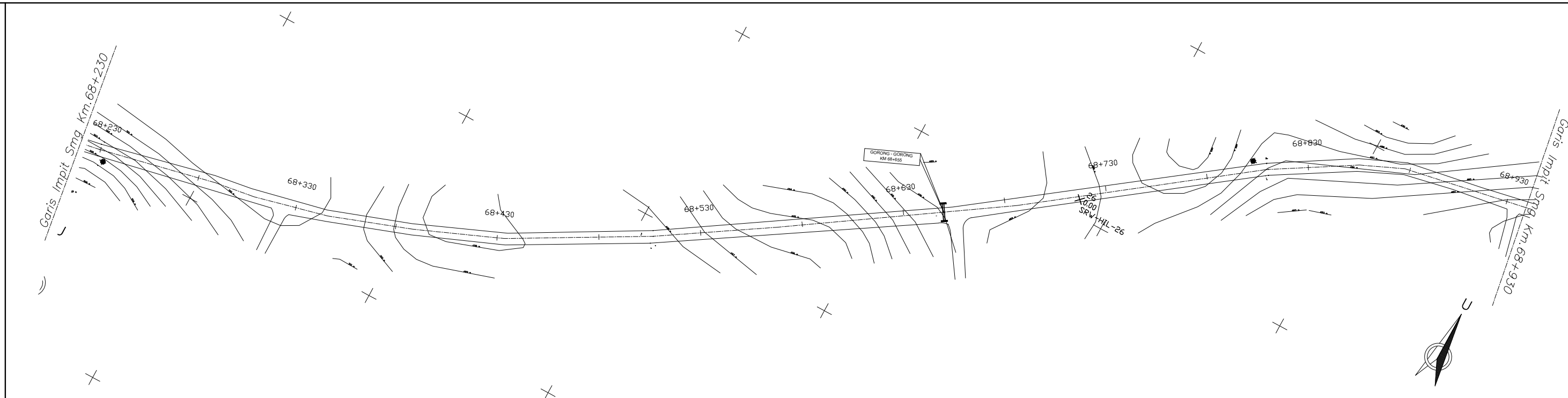

ALINYEMEN VERTIKAL
 SKALA TEGAK 1 : 500
 SKALA MEMANJANG 1 : 2000

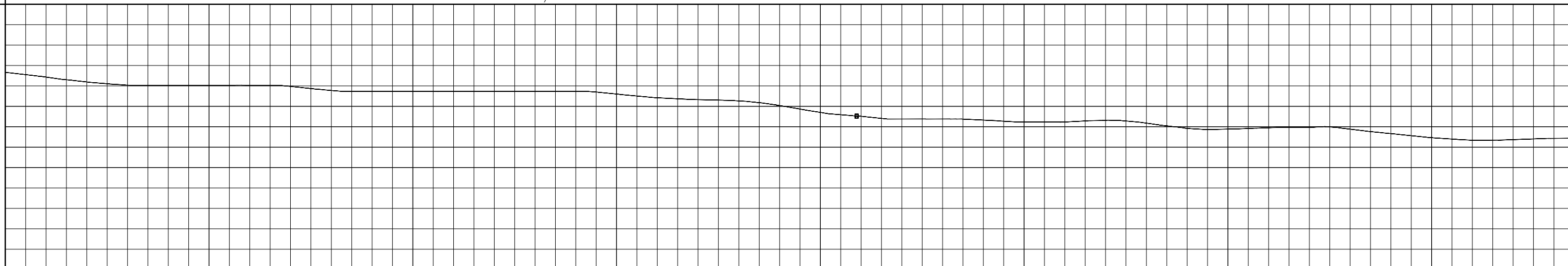

KETINGGIAN
 MUKA
 AS JALAN

504.21	500.50	500.00	498.94	498.00	498.00	497.14	495.17	491.16	489.00	488.00	488.35	485.69	486.41	482.90	482.49
--------	--------	--------	--------	--------	--------	--------	--------	--------	--------	--------	--------	--------	--------	--------	--------

SMG
 KM

68+230	68+330	68+430	68+530	68+630	68+730	68+830	68+930
--------	--------	--------	--------	--------	--------	--------	--------

PENAMPANG MELINTANG
 SKALA TEGAK 1 : 500 MEMANJANG 1 : 500

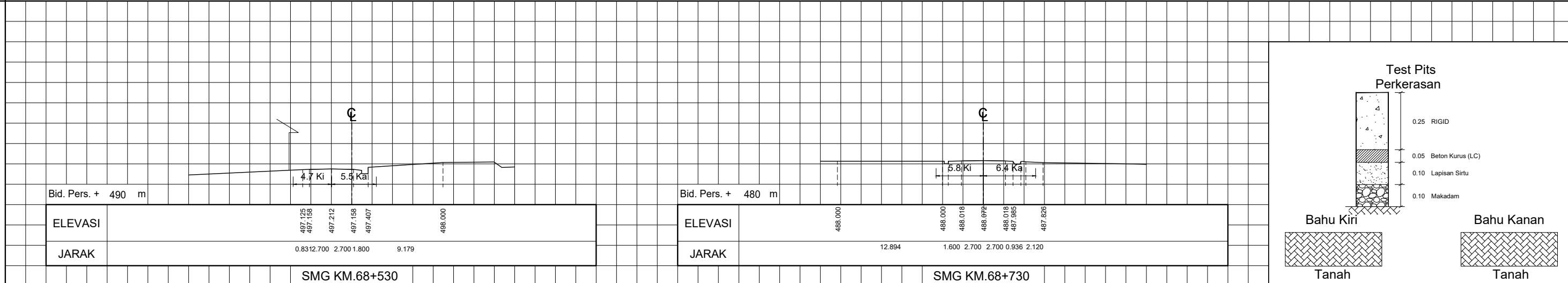

(HITAM) GAMBAR ASLI (BIRU) PEMUTAKHIRAN I (COKLAT) PEMUTAKHIRAN II (HIJAU) PEMUTAKHIRAN III (UNGU) PEMUTAKHIRAN IV

KETERANGAN GAMBAR DAPAT DILIHAT PADA LEMBAR LEGENDA



SMG KM. 68+930 S/D KM. 69+630

GAMBAR SITUASI DAN POTONGAN

ALINYEMEN HORIZONTAL
 SKALA LEBAR 1 : 2000 SKALA MEMANJANG 1 : 2000

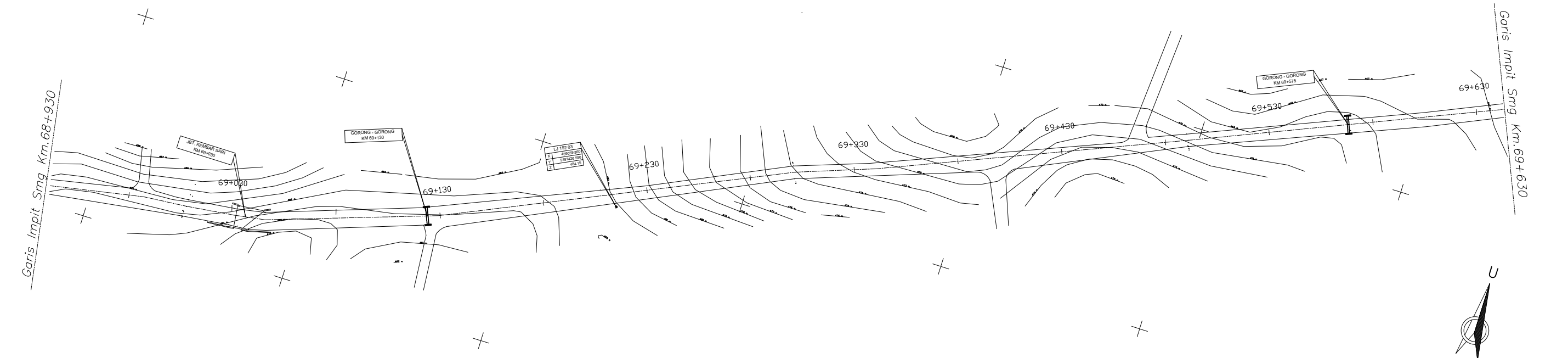

ALINYEMEN VERTIKAL
 SKALA TEPAK 1 : 500
 SKALA MEMANJANG 1 : 2000

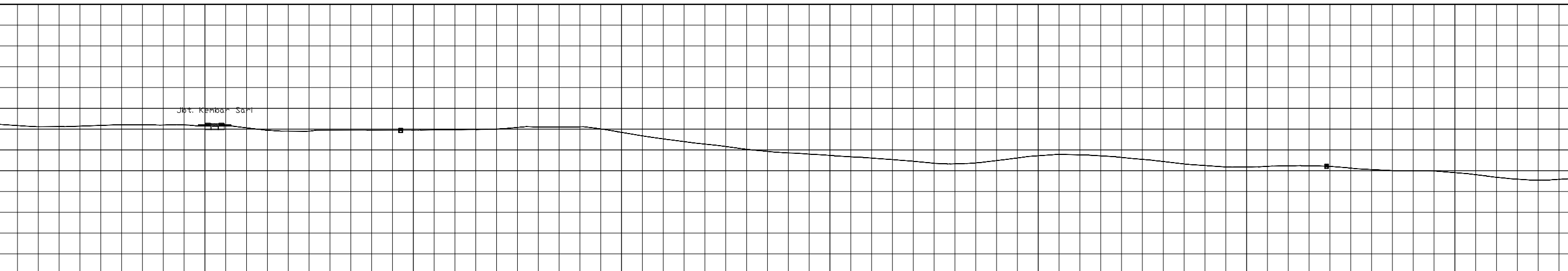

KETINGGIAN
 MUKA
 AS JALAN

482.90	482.49	482.32	480.67	481.00	481.66	480.26	475.74	472.89	470.37	472.78	471.60	469.18	468.81	467.35	465.23
--------	--------	--------	--------	--------	--------	--------	--------	--------	--------	--------	--------	--------	--------	--------	--------

SMG
 KM

68+930	69+030	69+130	69+230	69+330	69+430	69+530	69+630
--------	--------	--------	--------	--------	--------	--------	--------

PENAMPANG MELINTANG
 SKALA TEPAK 1 : 500 MEMANJANG 1 : 500

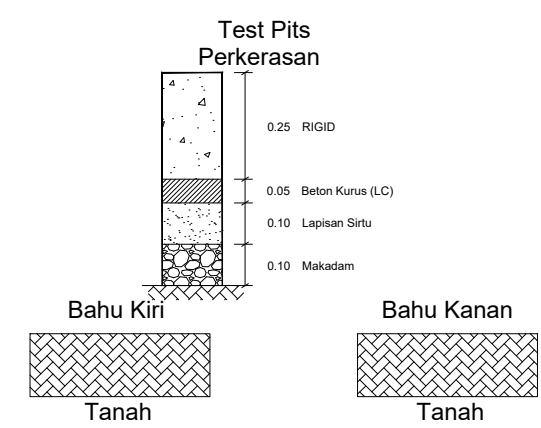
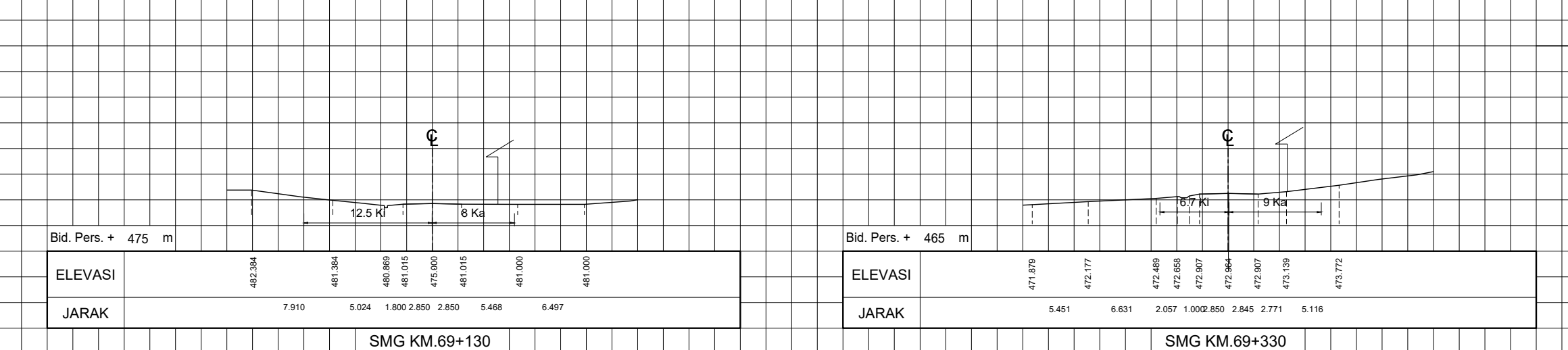

(HITAM) GAMBAR ASLI (BIRU) PEMUTAKHIRAN I (COKLAT) PEMUTAKHIRAN II (HIJAU) PEMUTAKHIRAN III (UNGU) PEMUTAKHIRAN IV

KETERANGAN GAMBAR DAPAT DILIHAT PADA LEMBAR LEGENDA



SMG KM. 69+630 S/D KM. 70+330

GAMBAR SITUASI DAN POTONGAN

ALINYEMEN HORIZONTAL
 SKALA LEBAR 1 : 2000 SKALA MEMANJANG 1 : 2000

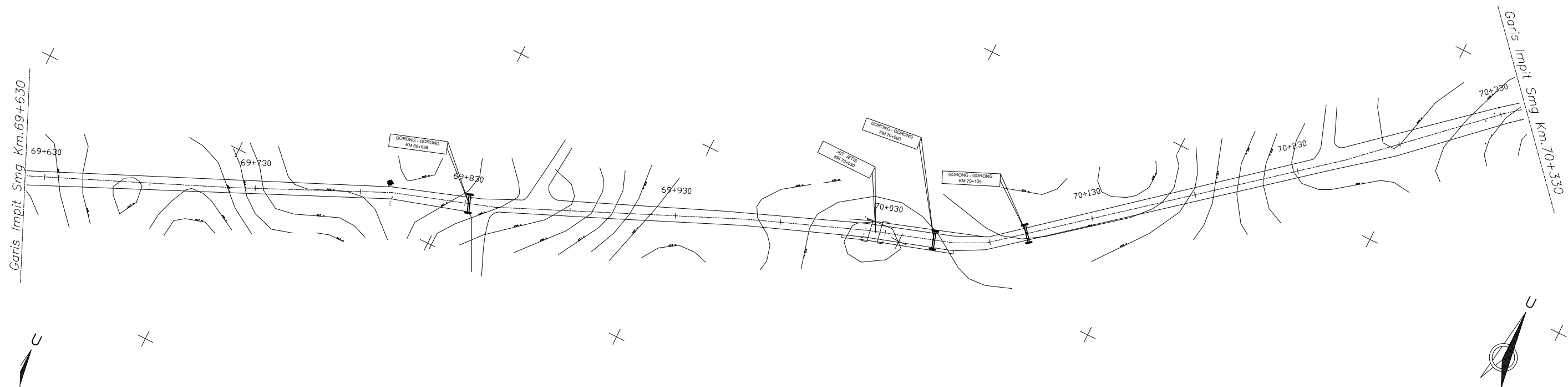

ALINYEMEN VERTIKAL
 SKALA TEGAK 1 : 500
 SKALA MEMANJANG 1 : 2000

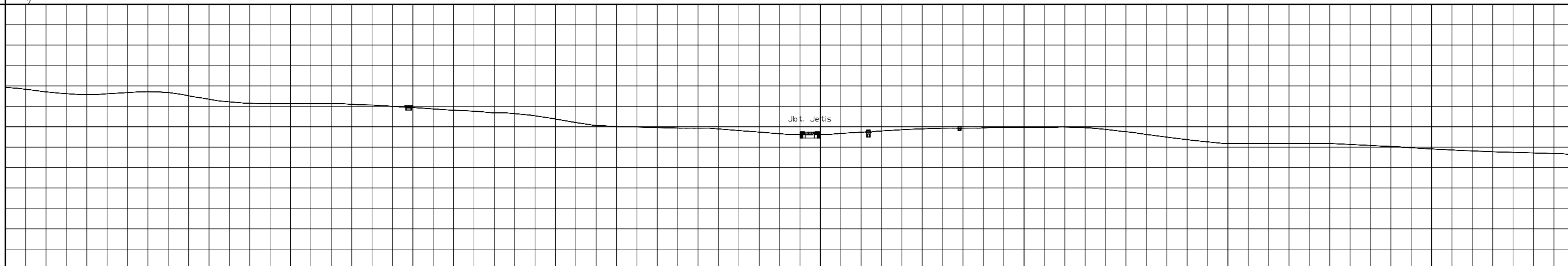

KETINGGIAN
 MUKA
 AS JALAN

467.35	465.23	463.45	462.00	460.62	458.77	454.51	453.77	452.00	453.77	454.30	452.84	449.00	449.00	447.24	445.93
--------	--------	--------	--------	--------	--------	--------	--------	--------	--------	--------	--------	--------	--------	--------	--------

SMG
 KM

69+630	69+730	69+830	69+930	70+030	70+130	70+230	70+330
--------	--------	--------	--------	--------	--------	--------	--------

PENAMPANG MELINTANG
 SKALA TEGAK 1 : 500 MEMANJANG 1 : 500

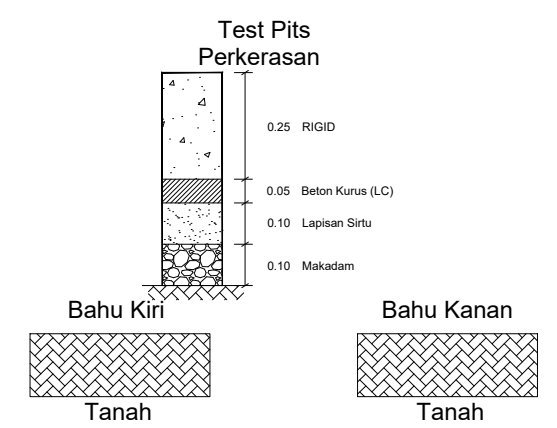
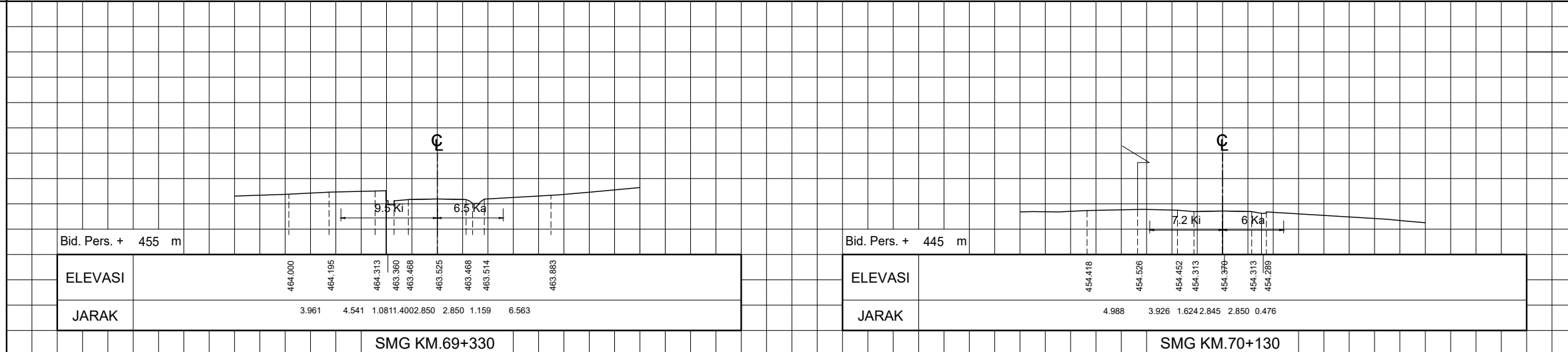

(HITAM) GAMBAR ASLI (BIRU) PEMUTAKHIRAN I (COKLAT) PEMUTAKHIRAN II (HIJAU) PEMUTAKHIRAN III (UNGU) PEMUTAKHIRAN IV

KETERANGAN GAMBAR DAPAT DILIHAT PADA LEMBAR LEGENDA



SMG KM. 70+330 S/D KM. 71+030

GAMBAR SITUASI DAN POTONGAN

ALINYEMEN HORIZONTAL
SKALA LEBAR 1 : 2000 SKALA MEMANJANG 1 : 2000

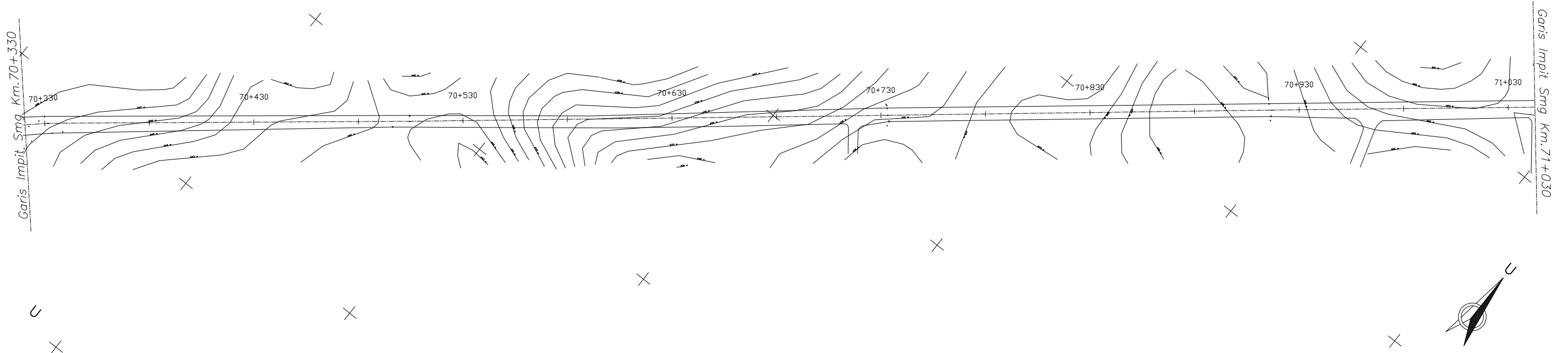

ALINYEMEN VERTIKAL
SKALA TEGAK 1 : 500
SKALA MEMANJANG 1 : 2000

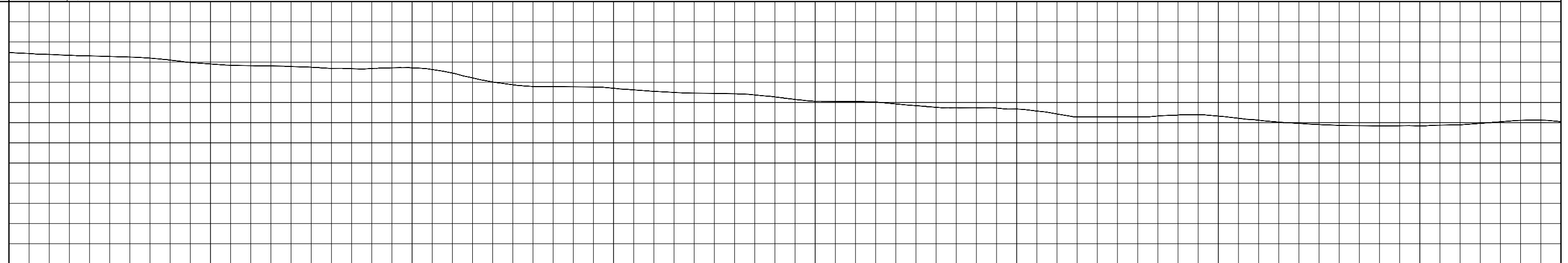

KETINGGIAN
MUKA
AS JALAN

447.24	445.93	443.45	442.38	442.18	436.58	435.41	433.73	431.15	429.67	428.55	426.00	426.23	423.45	423.00	424.83
--------	--------	--------	--------	--------	--------	--------	--------	--------	--------	--------	--------	--------	--------	--------	--------

SMG
KM

70+330	70+430	70+530	70+630	70+730	70+830	70+930	71+030
--------	--------	--------	--------	--------	--------	--------	--------

PENAMPANG MELINTANG
SKALA TEGAK 1 : 500 MEMANJANG 1 : 500

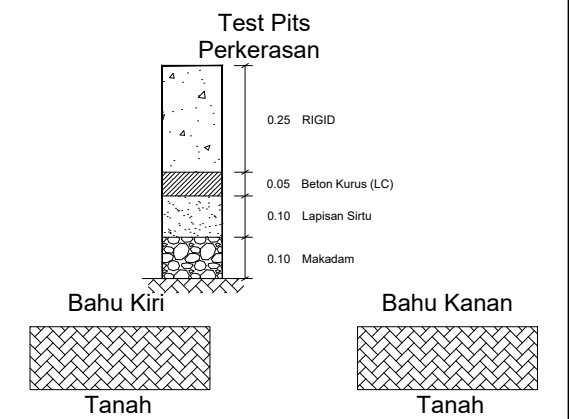
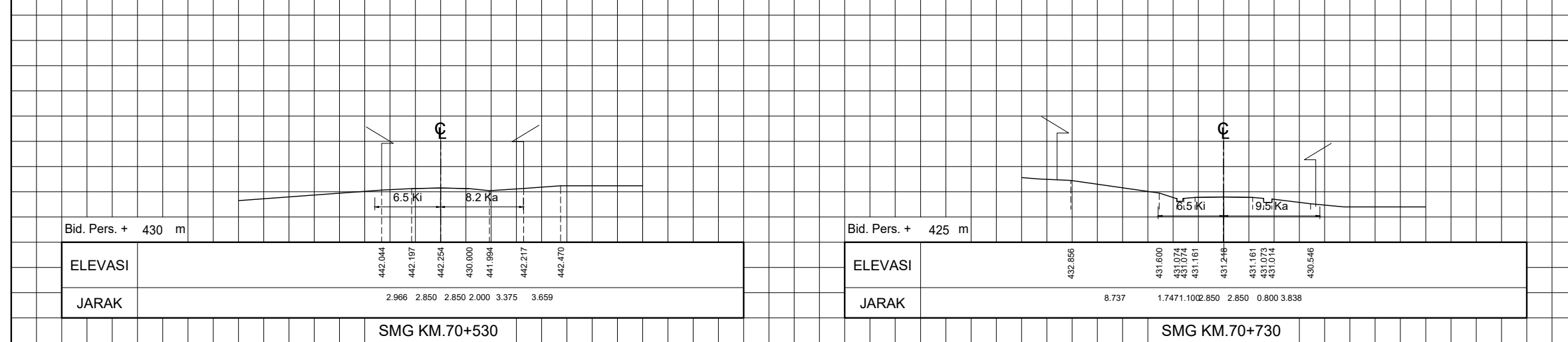

(HITAM) GAMBAR ASLI (BIRU) PEMUTAKHIRAN I (COKLAT) PEMUTAKHIRAN II (HIJAU) PEMUTAKHIRAN III (UNGU) PEMUTAKHIRAN IV

KETERANGAN GAMBAR DAPAT DILIHAT PADA LEMBAR LEGENDA



SMG KM. 71+030 S/D KM. 71+730

GAMBAR SITUASI DAN POTONGAN

ALINYEMEN HORIZONTAL
 SKALA LEBAR 1 : 2000 SKALA MEMANJANG 1 : 2000

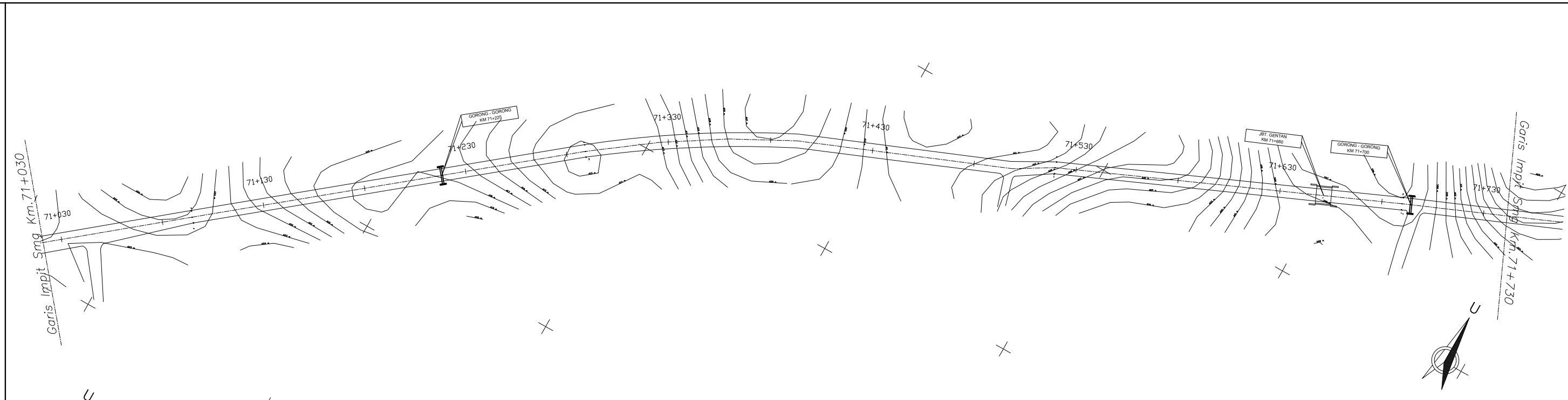

ALINYEMEN VERTIKAL
 SKALA TEGAK 1 : 500
 SKALA MEMANJANG 1 : 2000

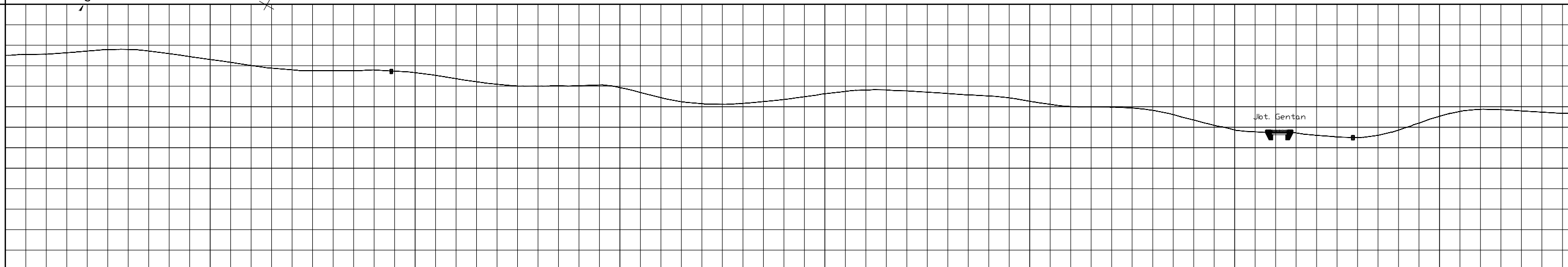

KETINGGIAN
 MUKA
 AS JALAN

423.00	424.83	421.63	418.00	417.33	413.00	412.48	407.04	410.48	411.01	408.03	405.85	398.70	396.45	403.17	404.50
--------	--------	--------	--------	--------	--------	--------	--------	--------	--------	--------	--------	--------	--------	--------	--------

SMG
 KM

71+030	71+130	71+230	71+330	71+430	71+530	71+630	71+730
--------	--------	--------	--------	--------	--------	--------	--------

PENAMPANG MELINTANG
 SKALA TEGAK 1 : 500 MEMANJANG 1 : 500

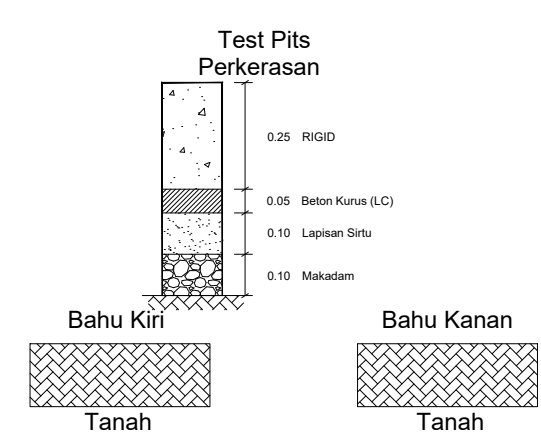
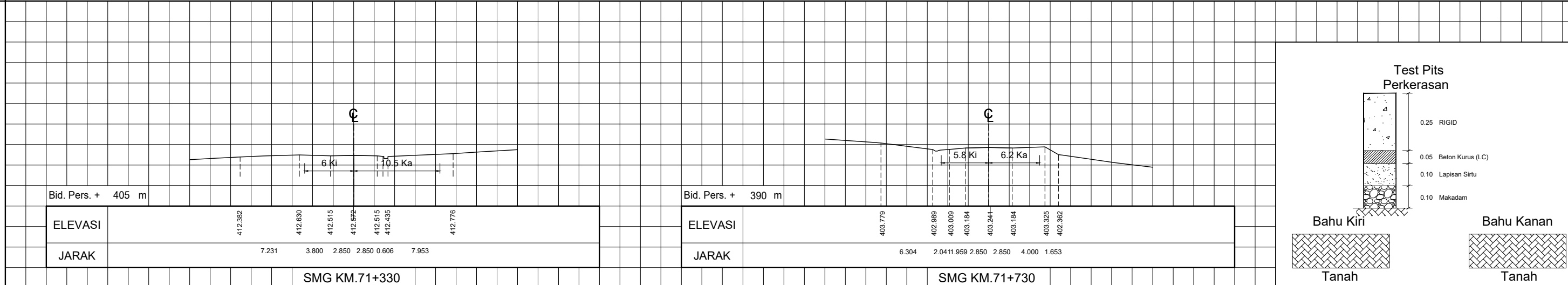

(HITAM) GAMBAR ASLI (BIRU) PEMUTAKHIRAN I (COKLAT) PEMUTAKHIRAN II (HIJAU) PEMUTAKHIRAN III (UNGU) PEMUTAKHIRAN IV

KETERANGAN GAMBAR DAPAT DILIHAT PADA LEMBAR LEGENDA



SMG KM. 71+730 S/D KM. 72+430

GAMBAR SITUASI DAN POTONGAN

ALINYEMEN HORIZONTAL
 SKALA LEBAR 1 : 2000 SKALA MEMANJANG 1 : 2000

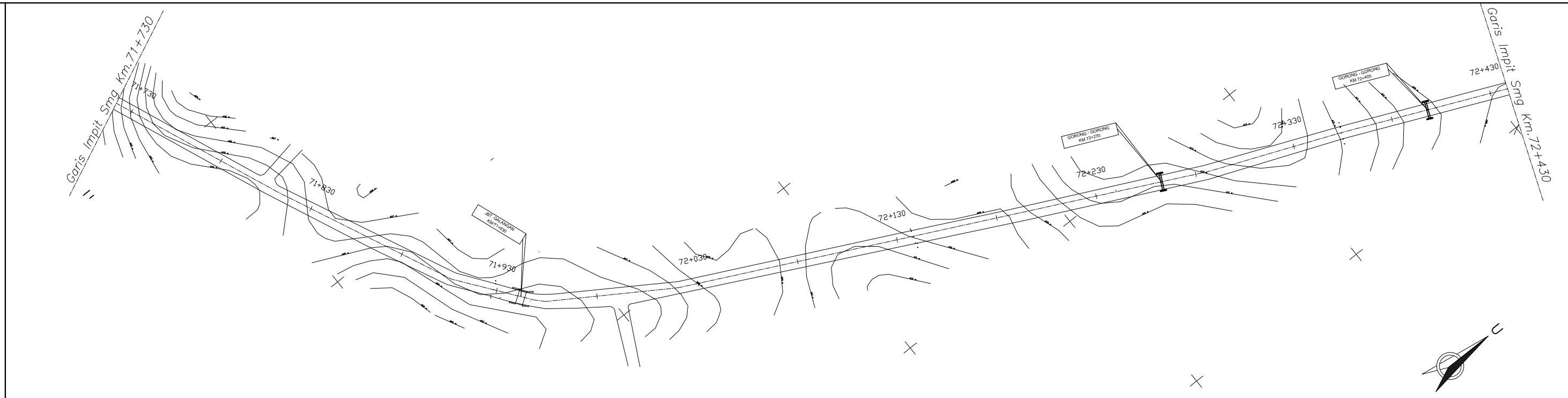

ALINYEMEN VERTIKAL
 SKALA TEGAK 1 : 500
 SKALA MEMANJANG 1 : 2000

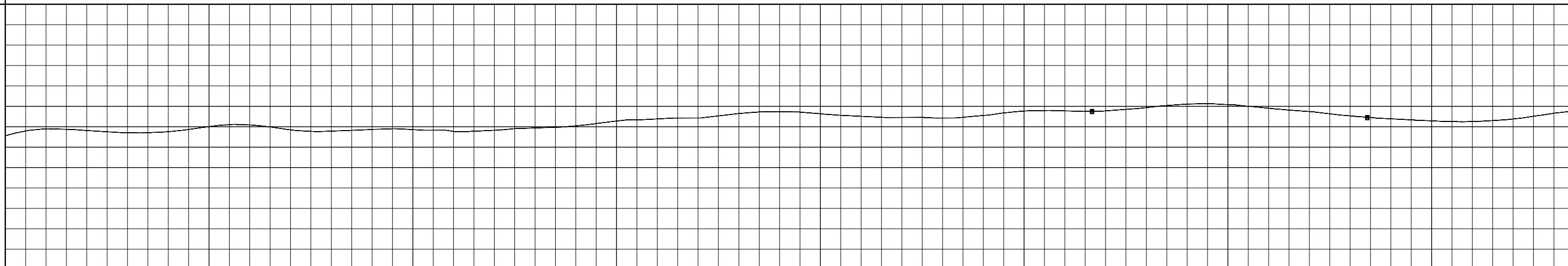

KETINGGIAN
 MUKA
 AS JALAN

403.17	404.50	406.17	404.64	405.20	405.52	408.02	409.68	410.37	409.17	411.24	411.81	413.36	410.35	408.07	409.56
--------	--------	--------	--------	--------	--------	--------	--------	--------	--------	--------	--------	--------	--------	--------	--------

SMG
 KM

71+730	71+830	71+930	72+030	72+130	72+230	72+330	72+430
--------	--------	--------	--------	--------	--------	--------	--------

PENAMPANG MELINTANG
 SKALA TEGAK 1 : 500 MEMANJANG 1 : 500

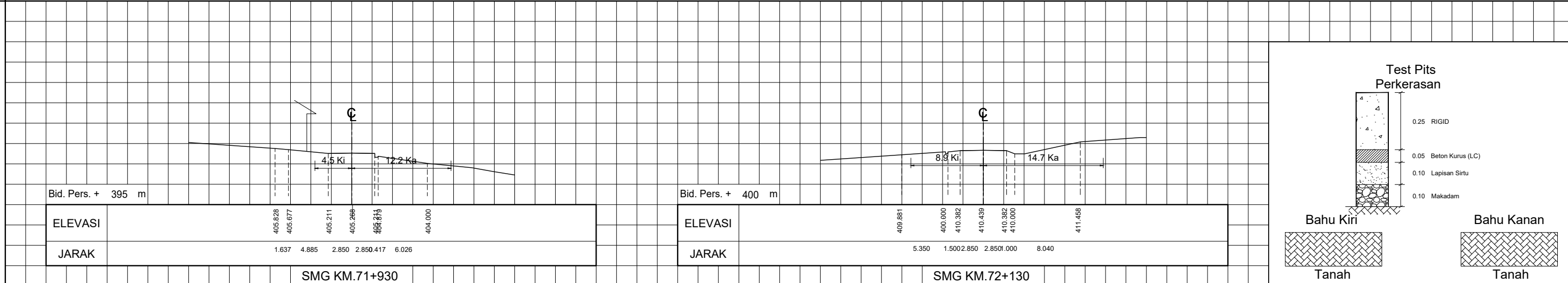

(HITAM) GAMBAR ASLI (BIRU) PEMUTAKHIRAN I (COKLAT) PEMUTAKHIRAN II (HIJAU) PEMUTAKHIRAN III (UNGU) PEMUTAKHIRAN IV

KETERANGAN GAMBAR DAPAT DILIHAT PADA LEMBAR LEGENDA



SMG KM. 73+130 S/D KM. 73+830

GAMBAR SITUASI DAN POTONGAN

ALINYEMEN HORIZONTAL
SKALA LEBAR 1 : 2000 SKALA MEMANJANG 1 : 2000

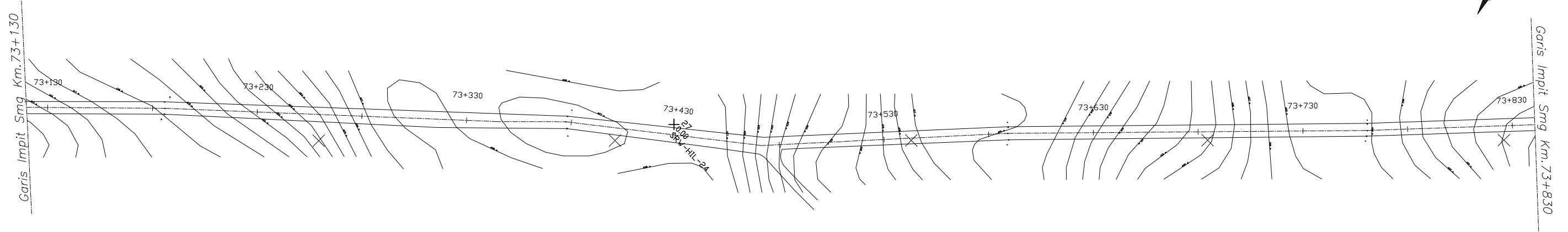

ALINYEMEN VERTIKAL
SKALA TEGAK 1 : 500
SKALA MEMANJANG 1 : 2000



KETINGGIAN
MUKA
AS JALAN

415.24	417.96	421.22	426.67	427.74	427.00	428.00	423.08	418.92	416.00	413.21	409.64	404.69	402.68	398.83	395.82
--------	--------	--------	--------	--------	--------	--------	--------	--------	--------	--------	--------	--------	--------	--------	--------

SMG
KM

73+130	73+230	73+330	73+430	73+530	73+630	73+730	73+830
--------	--------	--------	--------	--------	--------	--------	--------

PENAMPANG MELINTANG
SKALA TEGAK 1 : 500 MEMANJANG 1 : 500

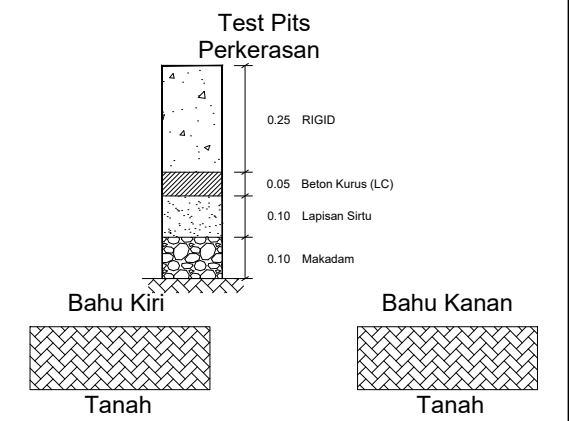
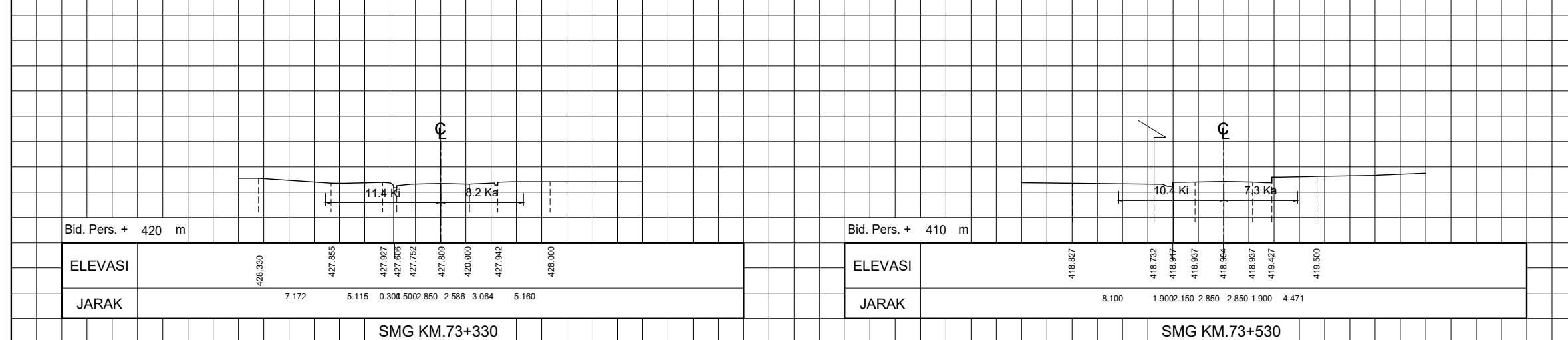

(HITAM) GAMBAR ASLI (BIRU) PEMUTAKHIRAN I (COKLAT) PEMUTAKHIRAN II (HIJAU) PEMUTAKHIRAN III (UNGU) PEMUTAKHIRAN IV

KETERANGAN GAMBAR DAPAT DILIHAT PADA LEMBAR LEGENDA



SMG KM. 73+830 S/D KM. 74+530

GAMBAR SITUASI DAN POTONGAN

ALINYEMEN HORIZONTAL
 SKALA LEBAR 1 : 2000 SKALA MEMANJANG 1 : 2000

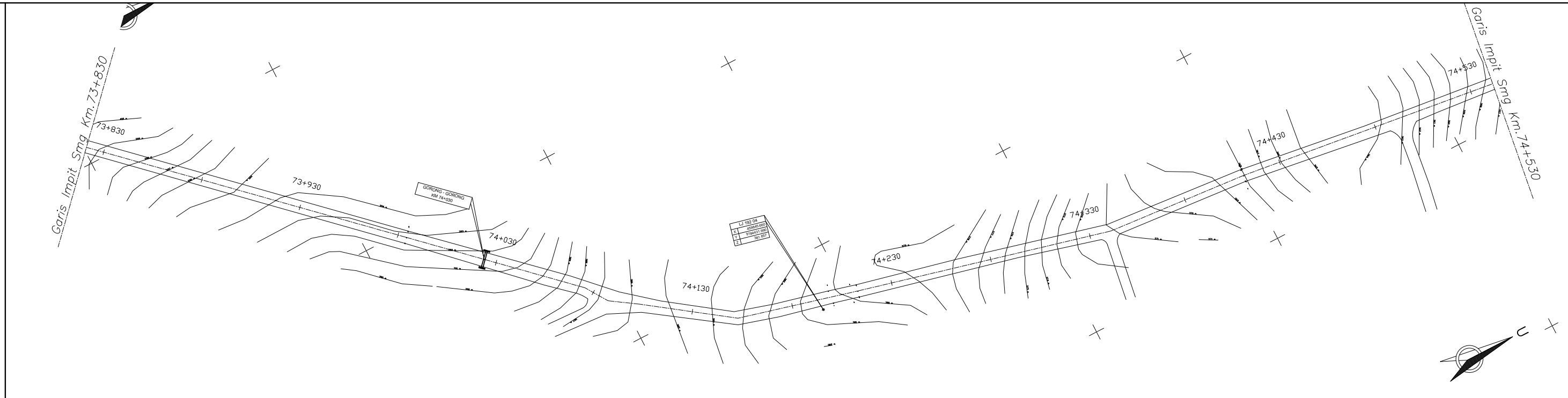

ALINYEMEN VERTIKAL
 SKALA TEGAK 1 : 500
 SKALA MEMANJANG 1 : 2000

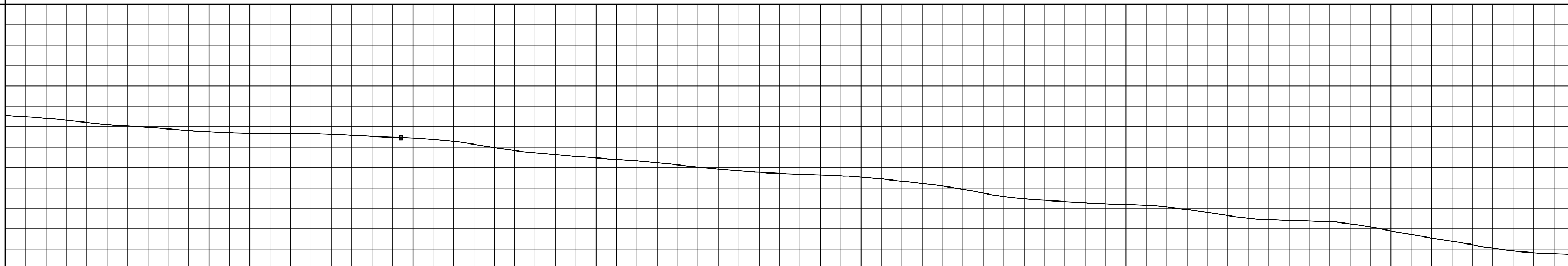

KETINGGIAN
 MUKA
 AS JALAN

398.83	395.82	393.45	392.80	391.42	387.31	384.44	381.26	379.37	376.59	371.57	369.68	366.07	364.07	358.74	353.97
--------	--------	--------	--------	--------	--------	--------	--------	--------	--------	--------	--------	--------	--------	--------	--------

SMG KM

73+830	73+930	74+030	74+130	74+230	74+330	74+430	74+530
--------	--------	--------	--------	--------	--------	--------	--------

PENAMPANG MELINTANG
 SKALA TEGAK 1 : 500 MEMANJANG 1 : 500

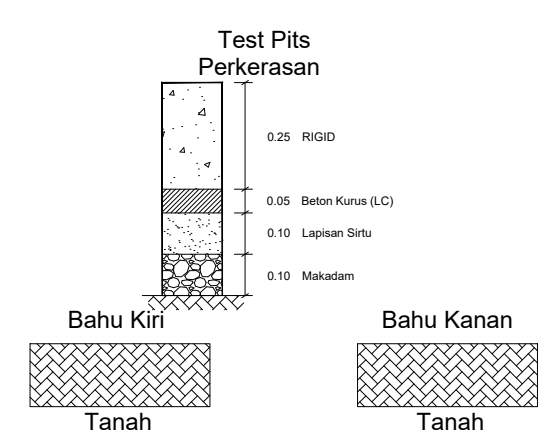
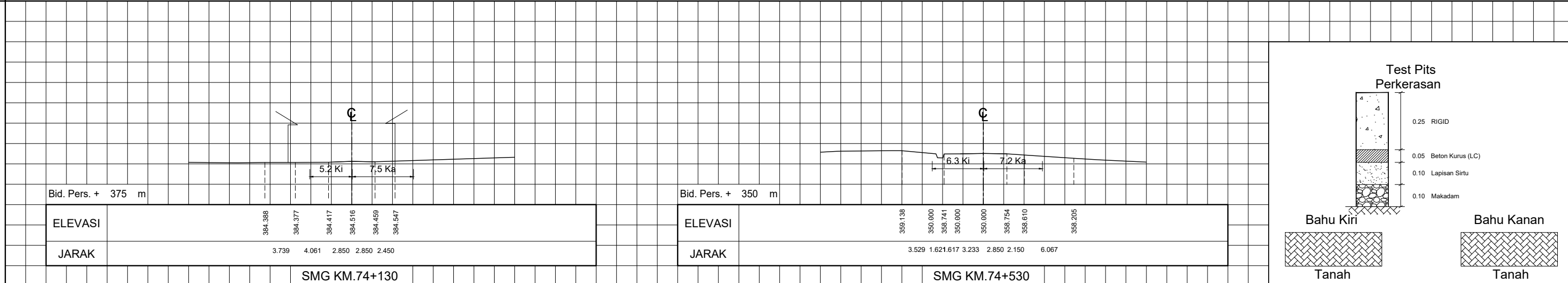

SMG KM.74+130 SMG KM.74+530

(HITAM) GAMBAR ASLI (BIRU) PEMUTAKHIRAN I (COKLAT) PEMUTAKHIRAN II (HIJAU) PEMUTAKHIRAN III (UNGU) PEMUTAKHIRAN IV

KETERANGAN GAMBAR DAPAT DILIHAT PADA LEMBAR LEGENDA



SMG KM. 74+530 S/D KM. 74+660

GAMBAR SITUASI DAN POTONGAN

ALINYEMEN HORIZONTAL
 SKALA LEBAR 1 : 2000 SKALA MEMANJANG 1 : 2000

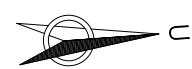
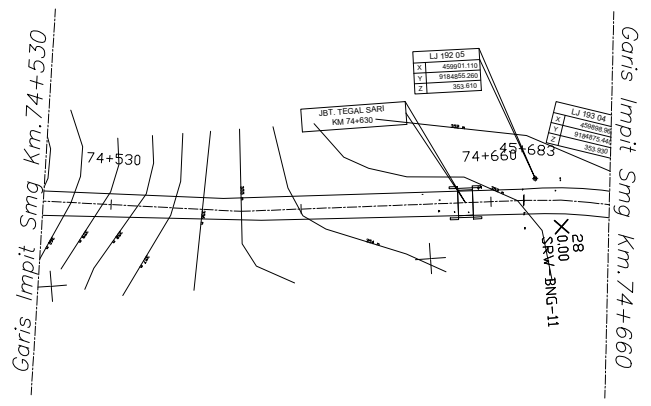

ALINYEMEN VERTIKAL
 SKALA TEGAK 1 : 500
 SKALA MEMANJANG 1 : 2000

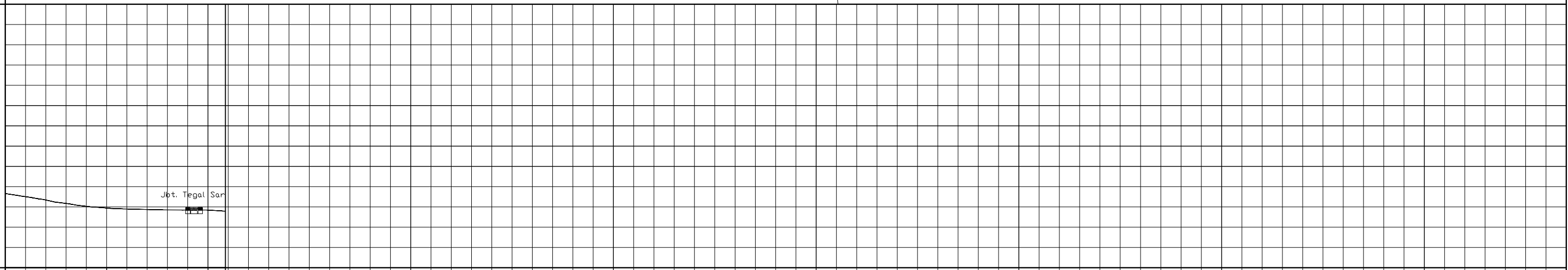

KETINGGIAN
 MUKA
 AS JALAN

358.74	353.97	353.12
--------	--------	--------

SMG
 KM

74+530	74+630
--------	--------

PENAMPANG MELINTANG
 SKALA TEGAK 1 : 500 MEMANJANG 1 : 500

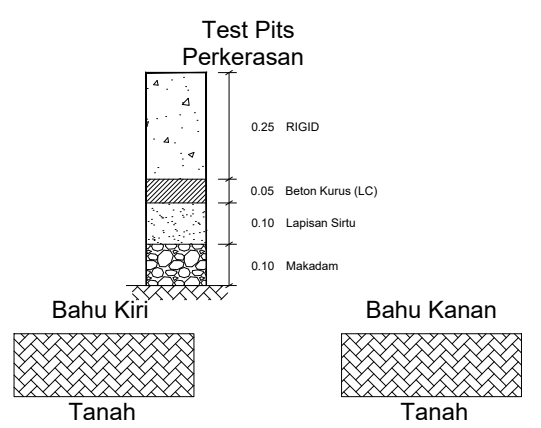
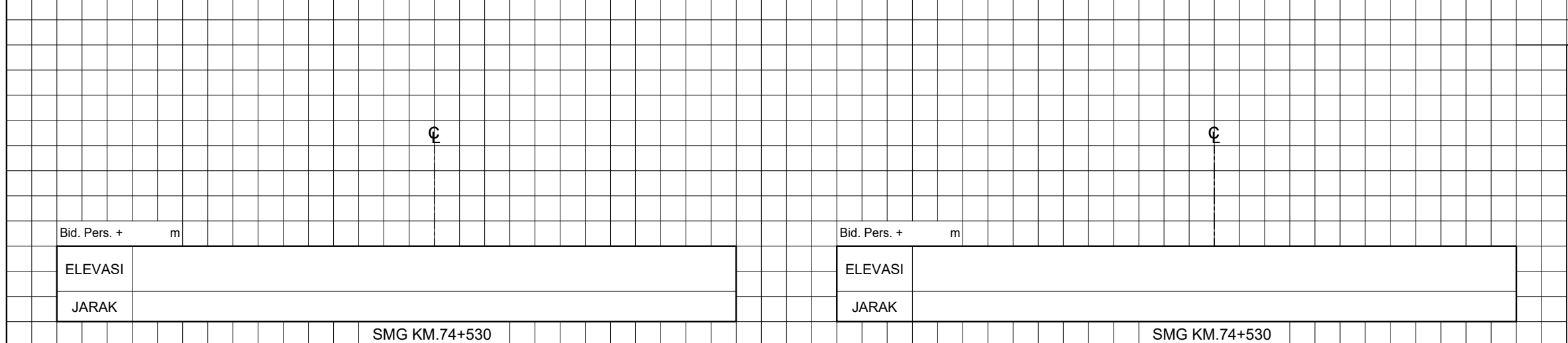

(HITAM) GAMBAR ASLI (BIRU) PEMUTAKHIRAN I (COKLAT) PEMUTAKHIRAN II (HIJAU) PEMUTAKHIRAN III (UNGU) PEMUTAKHIRAN IV

KETERANGAN GAMBAR DAPAT DILIHAT PADA LEMBAR LEGENDA