

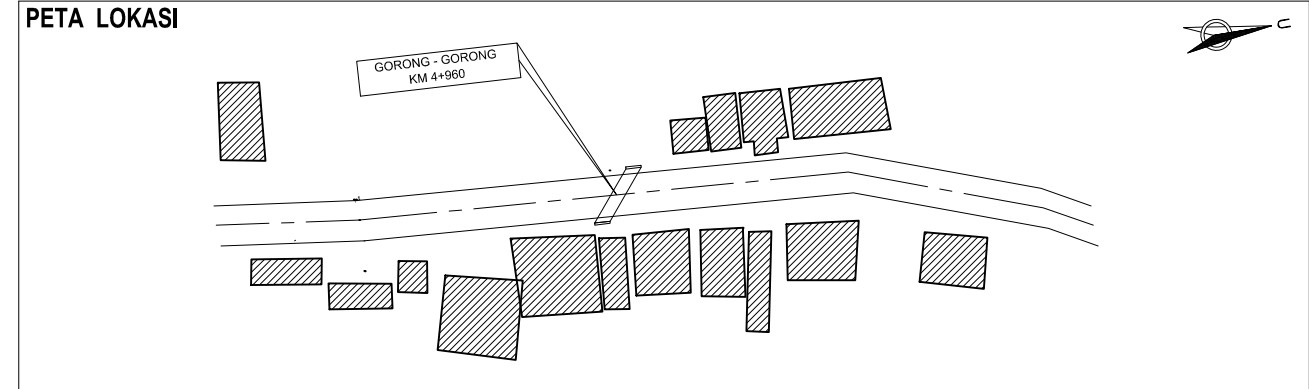

KONSTRUKSI DAN FOTO

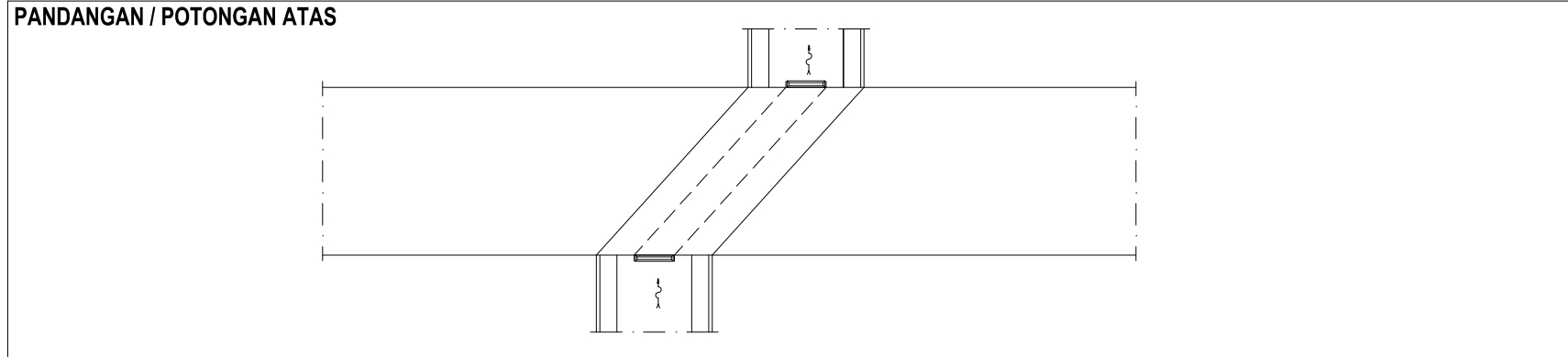
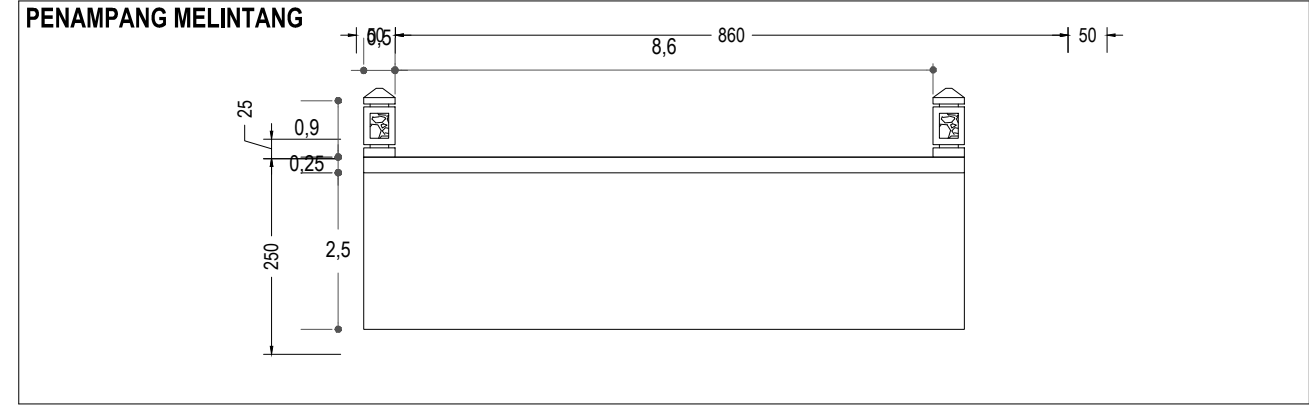
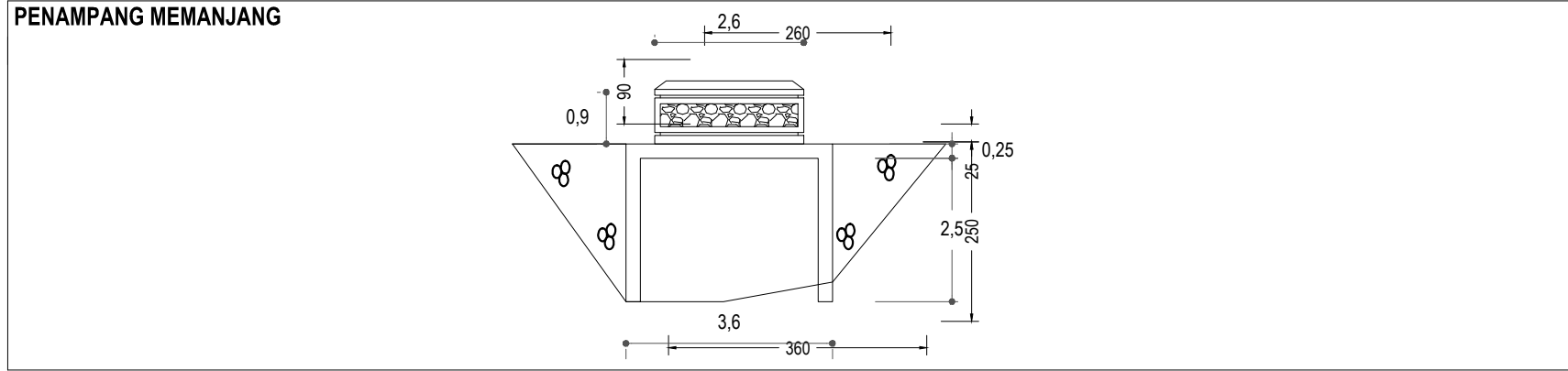

KEGIATAN POKOK	ASAL / TAHUN : 2022				PEMUTAKHIRAN I / TAHUN :				PEMUTAKHIRAN II / TAHUN :				PEMUTAKHIRAN III / TAHUN :				PEMUTAKHIRAN IV / TAHUN :				PEMUTAKHIRAN V / TAHUN :				
	PELAKSANA	CACAH	BIAYA Rp. 10 ³	SUMBER DANA	PELAKSANA	CACAH	BIAYA Rp. 10 ³	SUMBER DANA	PELAKSANA	CACAH	BIAYA Rp. 10 ³	SUMBER DANA	PELAKSANA	CACAH	BIAYA Rp. 10 ³	SUMBER DANA	PELAKSANA	CACAH	BIAYA Rp. 10 ³	SUMBER DANA	PELAKSANA	CACAH	BIAYA Rp. 10 ³	SUMBER DANA	
1. DESAIN																									
2. PEMBEBASAN LAHAN																									
3. PEMBANGUNAN																									
4. PENGANTIAN																									
5. PENINGKATAN																									
6. PENUNJANG																									
7. PEMELIHARAAN & REHAB.																									
8. PEMELIHARAAN BERKALA																									
9. SUPERVISI																									
	JUMLAH				JUMLAH				JUMLAH				JUMLAH				JUMLAH								

TGL	BLN	TH.	MACAM KERUSAKAN	PEROLEHAN DATA	SEBAB KERUSAKAN	TGL	BLN	TH.	URAIAN	SIFAT	CACAH	BIAYA	PARAF
				TGL	BLN	TH.							

NO.	URAIAN	TGL	BLN	TH.	OLEH	PARAF
1	LALU LINTAS					
2	LONGSORAN					
3	GETARAN					
4	ALIRAN SUNGAI					
5	GEOLOGI					
6	PENY. TANAH					
7	FINAL REPORT					
8	KALENDERING					
9	STUDI KELAYAKAN					
10	SURVEI KONDISI					
11	AS BUILD DRAWING					

TITLE	DATE	SIGNATURE

KEGIATAN	ASAL 2012		PEMUTAKHIRAN I		PEMUTAKHIRAN II	
	TGL.	BLN. THN.	TGL.	BLN. THN.	TGL.	BLN. THN.
DIKUR	25	JULI 2022				
DIGAMBAR	8	AGUSTUS 2022				
DIKATAT	1	SEPTEMBER 2022				
DIPERIKSA	20	SEPTEMBER 2022				
DISETUJUI / DISAHKAN	SEMARANG		SEMARANG		SEMARANG	
DI	TGL. BLN. THN.		TGL. BLN. THN.		TGL. BLN. THN.	
OLEH	ALU HUDA, S.T., M.T.		ALU HUDA, S.T., M.T.		ALU HUDA, S.T., M.T.	



KONSTRUKSI DAN FOTO

PENAMPANG MEMANJANG

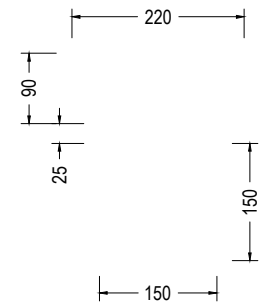

PENAMPANG MELINTANG

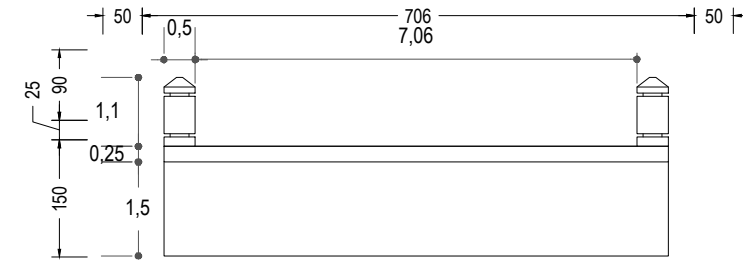

PANDANGAN / POTONGAN ATAS

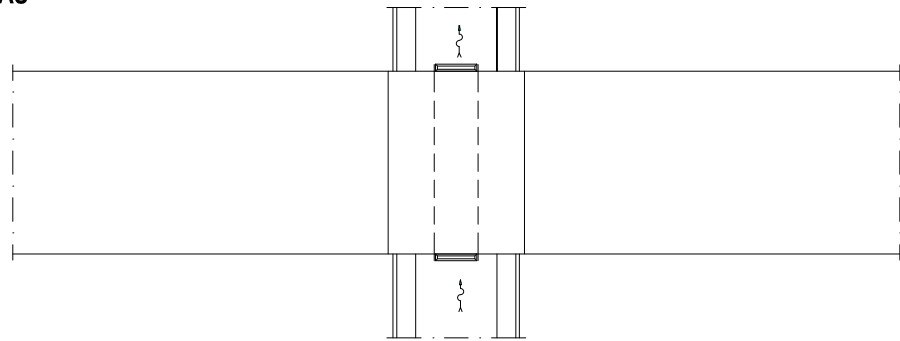

PETA LOKASI



FOTO PANDANGAN SAMPING DARI HULU / HILIR



FOTO JALAN PANDANGAN DEPAN GORONG-GORONG

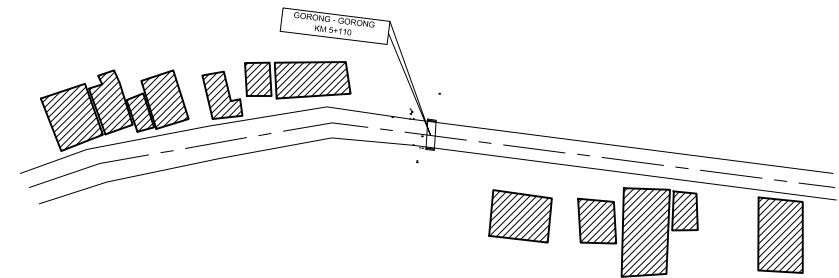

KONDISI UMUM - 2

KEGIATAN POKOK	ASAL / TAHUN : 2022				PEMUTAKHIRAN I / TAHUN :				PEMUTAKHIRAN II / TAHUN :				PEMUTAKHIRAN III / TAHUN :				PEMUTAKHIRAN IV / TAHUN :				PEMUTAKHIRAN V / TAHUN :				
	PELAKSANA	CACAH	BIAYA Rp. 10 ³	SUMBER DANA	PELAKSANA	CACAH	BIAYA Rp. 10 ³	SUMBER DANA	PELAKSANA	CACAH	BIAYA Rp. 10 ³	SUMBER DANA	PELAKSANA	CACAH	BIAYA Rp. 10 ³	SUMBER DANA	PELAKSANA	CACAH	BIAYA Rp. 10 ³	SUMBER DANA	PELAKSANA	CACAH	BIAYA Rp. 10 ³	SUMBER DANA	
1. DESAIN																									
2. PEMBEBASAN LAHAN																									
3. PEMBANGUNAN																									
4. PENGANTIAN																									
5. PENINGKATAN																									
6. PENUNJANG																									
7. PEMELIHARAAN & REHAB.																									
8. PEMELIHARAAN BERKALA																									
9. SUPERVISI																									
	JUMLAH				JUMLAH				JUMLAH				JUMLAH				JUMLAH								

RIWAYAT

TGL	BLN	TH.	MACAM KERUSAKAN	PEROLEHAN DATA		SEBAB KERUSAKAN	TGL	BLN	TH.	URAIAN	SIFAT	CACAH	BIAYA	PARAF
				TGL	BLN	TH.								

REFERENSI

NO.	URAIAN	TGL	BLN	TH.	OLEH	PARAF
1	LALU LINTAS					
2	LONGSORAN					
3	GETARAN					
4	ALIRAN SUNGAI					
5	GEOLOGI					
6	PENY. TANAH					
7	FINAL REPORT					
8	KALENDERING					
9	STUDI KELAYAKAN					
10	SURVEI KONDISI					
11	AS BUILD DRAWING					

CATATAN KHUSUS

--

LEGALISASI

KEGIATAN	ASAL 2012		PEMUTAKHIRAN I		PEMUTAKHIRAN II	
	TGL.	BLN.	THN.	TGL.	BLN.	THN.
DIUKUR	25	JULI	2022			
DIGAMBAR	8	AGUSTUS	2022			
DIKATAT	1	SEPTEMBER	2022			
DIPERIKSA	20	SEPTEMBER	2022			
DISETUJUI / DISAHKAN						
DI	SEMARANG					
TGL.	BLN.	THN.	24 SEPTEMBER 2022			
OLEH	ALI HUDA, S.T., M.T.					



KONSTRUKSI DAN FOTO

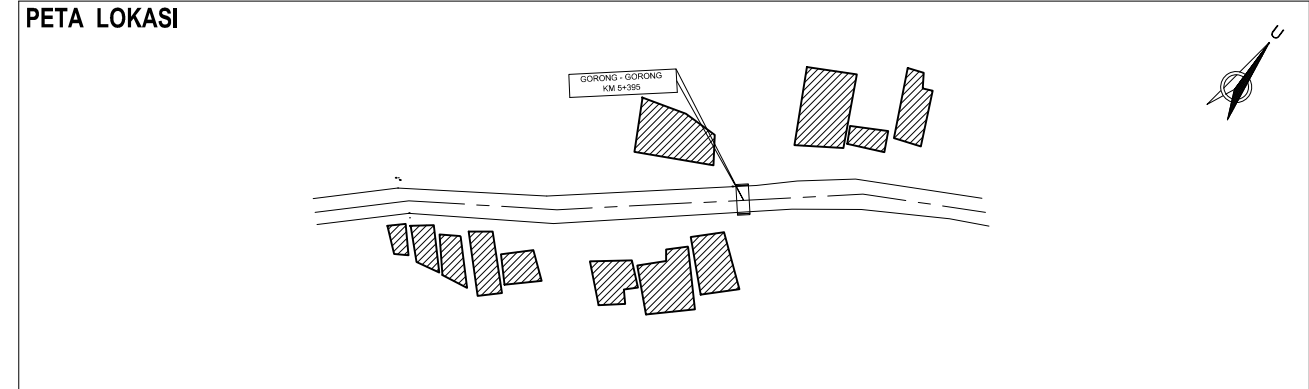
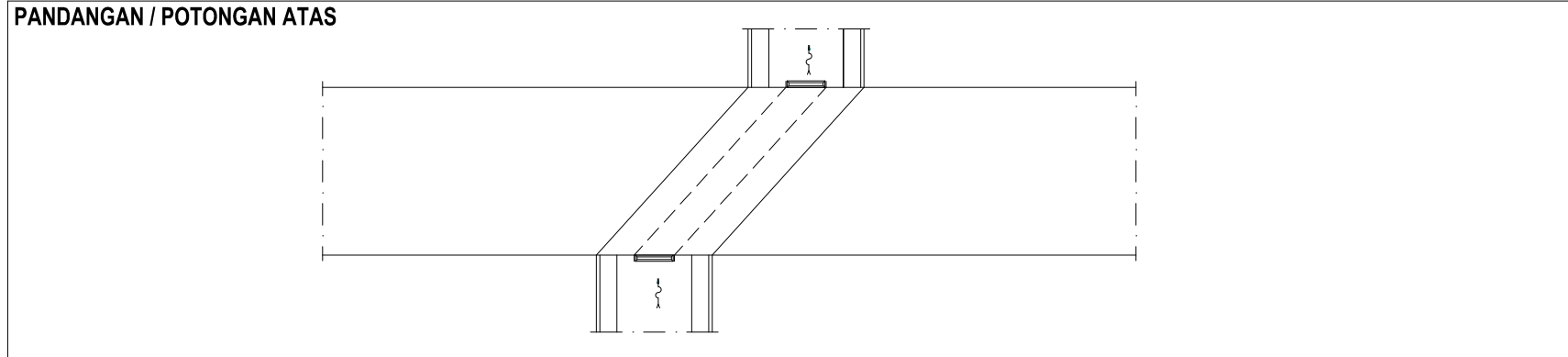
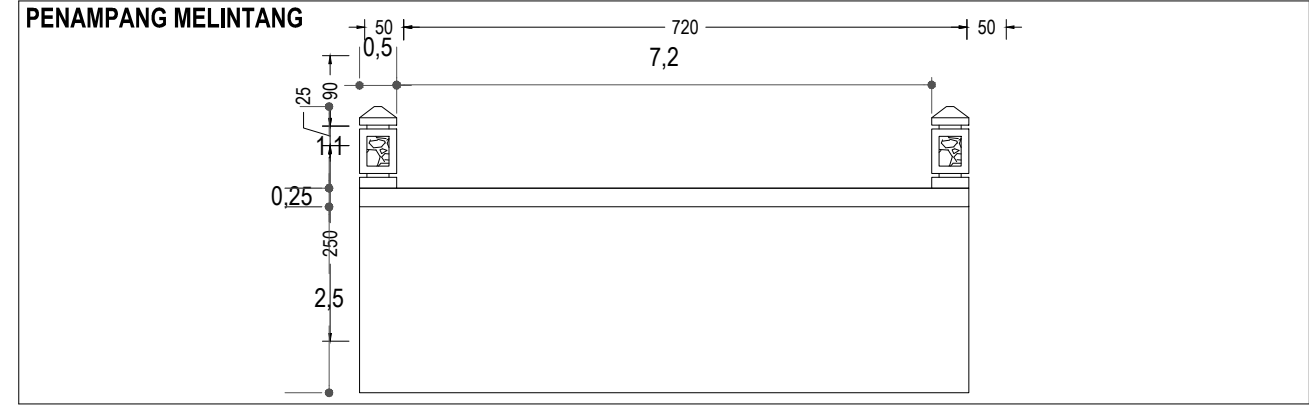
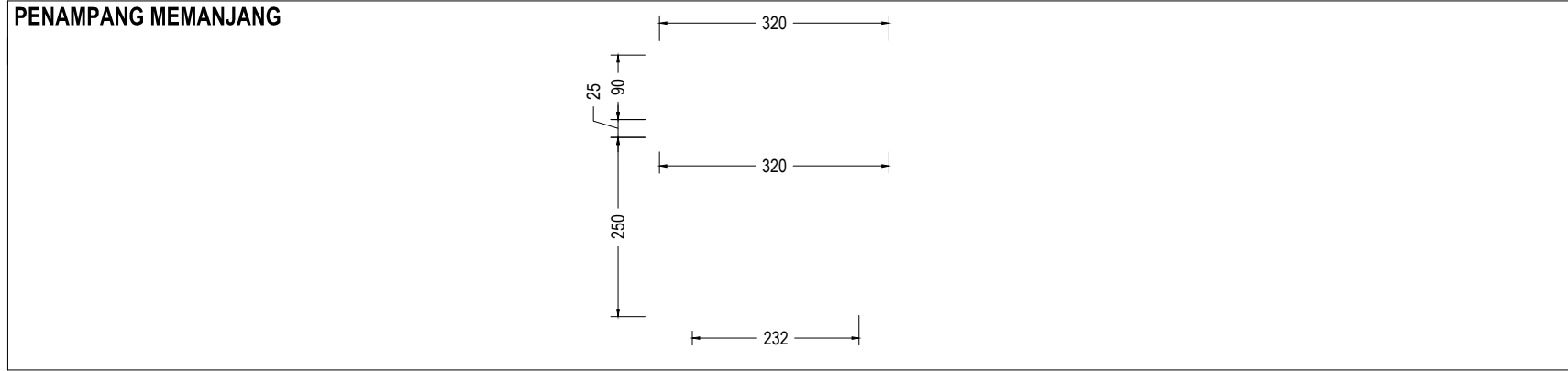

KONDISI UMUM - 2

KEGIATAN POKOK	ASAL / TAHUN : 2022				PEMUTAKHIRAN I / TAHUN :				PEMUTAKHIRAN II / TAHUN :				PEMUTAKHIRAN III / TAHUN :				PEMUTAKHIRAN IV / TAHUN :				PEMUTAKHIRAN V / TAHUN :				
	PELAKSANA	CACAH	BIAYA Rp. 10 ³	SUMBER DANA	PELAKSANA	CACAH	BIAYA Rp. 10 ³	SUMBER DANA	PELAKSANA	CACAH	BIAYA Rp. 10 ³	SUMBER DANA	PELAKSANA	CACAH	BIAYA Rp. 10 ³	SUMBER DANA	PELAKSANA	CACAH	BIAYA Rp. 10 ³	SUMBER DANA	PELAKSANA	CACAH	BIAYA Rp. 10 ³	SUMBER DANA	
1. DESAIN																									
2. PEMBEBASAN LAHAN																									
3. PEMBANGUNAN																									
4. PENGANTIAN																									
5. PENINGKATAN																									
6. PENUNJANG																									
7. PEMELIHARAAN & REHAB.																									
8. PEMELIHARAAN BERKALA																									
9. SUPERVISI																									
	JUMLAH				JUMLAH				JUMLAH				JUMLAH				JUMLAH								

RIWAYAT

TGL	BLN	TH.	MACAM KERUSAKAN	PEROLEHAN DATA		SEBAB KERUSAKAN	TGL	BLN	TH.	URAIAN	SIFAT	CACAH	BIAYA	PARAF
				TGL	BLN	TH.								

REFERENSI

NO.	URAIAN	TGL	BLN	TH.	OLEH	PARAF
1	LALU LINTAS					
2	LONGSORAN					
3	GETARAN					
4	ALIRAN SUNGAI					
5	GEOLOGI					
6	PENY. TANAH					
7	FINAL REPORT					
8	KALENDERING					
9	STUDI KELAYAKAN					
10	SURVEI KONDISI					
11	AS BUILD DRAWING					

CATATAN KHUSUS

--

LEGALISASI

KEGIATAN	ASAL 2012		PEMUTAKHIRAN I		PEMUTAKHIRAN II			
	TGL.	BLN.	THN.	TGL.	BLN.	THN.		
DIUKUR	25	JULI	2022					
DIGAMBAR	8	AGUSTUS	2022					
DIKATAT	1	SEPTEMBER	2022					
DIPERIKSA	20	SEPTEMBER	2022					
DISETUJUI / DISAHKAN								
DI	SEMARANG							
TGL.	BLN.	THN.	TGL.	BLN.	THN.	TGL.	BLN.	THN.
OLEH	ALY HUDA, S.T., M.T.							



KONSTRUKSI DAN FOTO

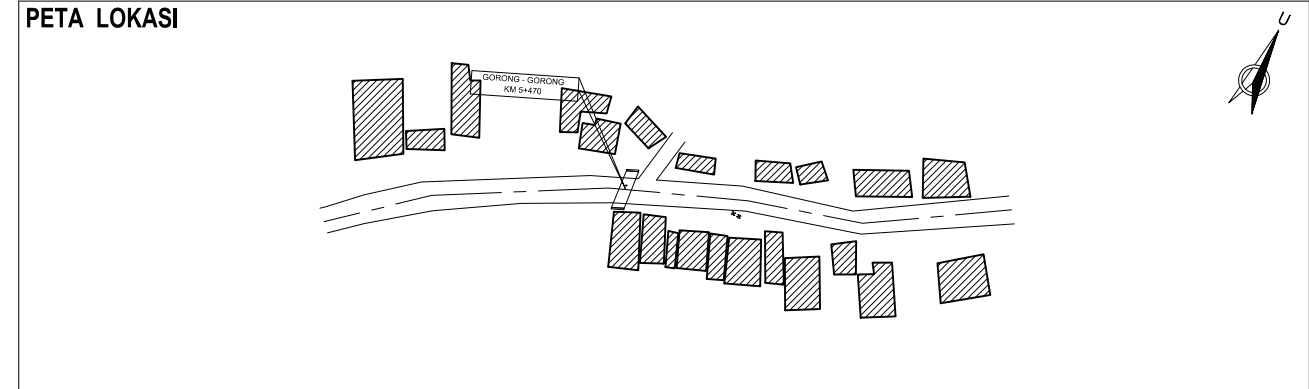
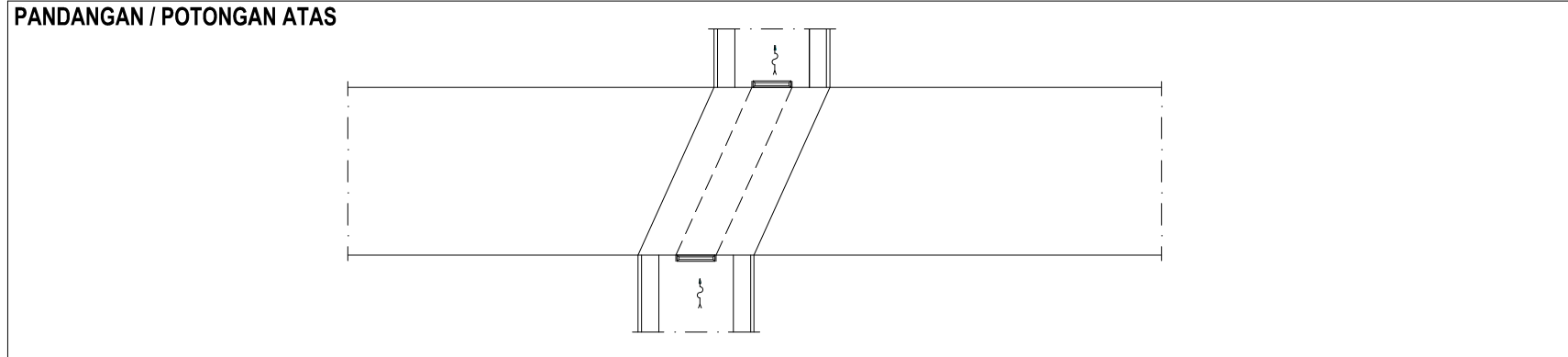
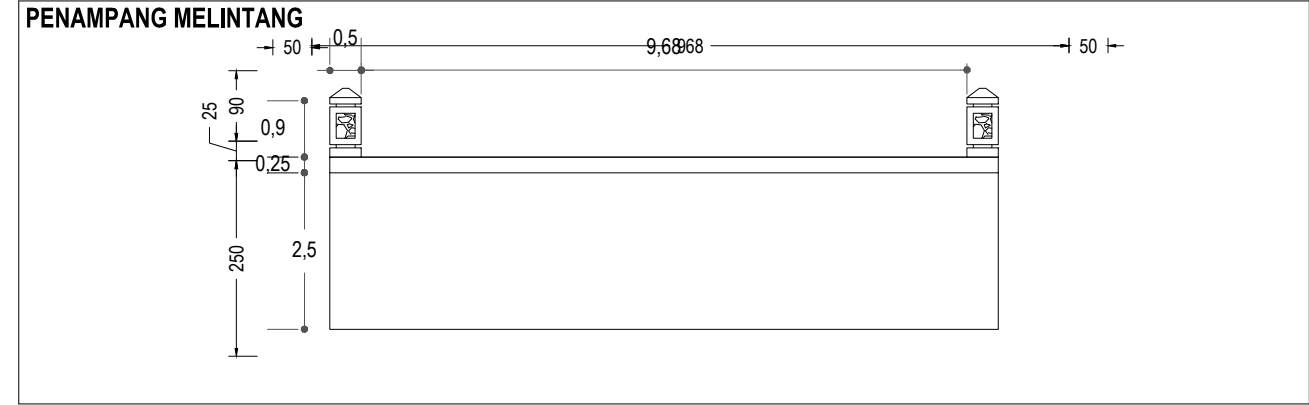
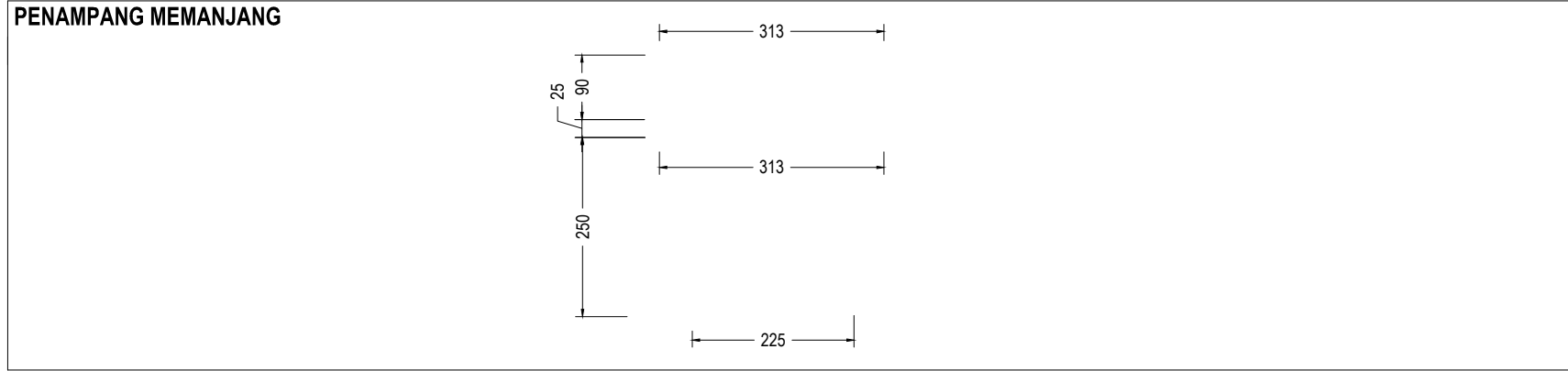

KONDISI UMUM - 2

KEGIATAN POKOK	ASAL / TAHUN : 2022				PEMUTAKHIRAN I / TAHUN :				PEMUTAKHIRAN II / TAHUN :				PEMUTAKHIRAN III / TAHUN :				PEMUTAKHIRAN IV / TAHUN :				PEMUTAKHIRAN V / TAHUN :				
	PELAKSANA	CACAH	BIAYA Rp. 10 ³	SUMBER DANA	PELAKSANA	CACAH	BIAYA Rp. 10 ³	SUMBER DANA	PELAKSANA	CACAH	BIAYA Rp. 10 ³	SUMBER DANA	PELAKSANA	CACAH	BIAYA Rp. 10 ³	SUMBER DANA	PELAKSANA	CACAH	BIAYA Rp. 10 ³	SUMBER DANA	PELAKSANA	CACAH	BIAYA Rp. 10 ³	SUMBER DANA	
1. DESAIN																									
2. PEMBEBASAN LAHAN																									
3. PEMBANGUNAN																									
4. PENGANTIAN																									
5. PENINGKATAN																									
6. PENUNJANG																									
7. PEMELIHARAAN & REHAB.																									
8. PEMELIHARAAN BERKALA																									
9. SUPERVISI																									
	JUMLAH				JUMLAH				JUMLAH				JUMLAH				JUMLAH								

RIWAYAT

TGL	BLN	TH.	MACAM KERUSAKAN	PEROLEHAN DATA		SEBAB KERUSAKAN	TGL	BLN	TH.	URAIAN	SIFAT	CACAH	BIAYA	PARAF
				TGL	BLN	TH.								

REFERENSI

NO.	URAIAN	TGL	BLN	TH.	OLEH	PARAF
1	LALU LINTAS					
2	LONGSORAN					
3	GETARAN					
4	ALIRAN SUNGAI					
5	GEOLOGI					
6	PENY. TANAH					
7	FINAL REPORT					
8	KALENDERING					
9	STUDI KELAYAKAN					
10	SURVEI KONDISI					
11	AS BUILD DRAWING					

CATATAN KHUSUS

--

LEGALISASI

KEGIATAN	ASAL 2012		PEMUTAKHIRAN I		PEMUTAKHIRAN II	
	TGL.	BLN.	THN.	TGL.	BLN.	THN.
DIUKUR	25	JULI	2022			
DIGAMBAR	8	AGUSTUS	2022			
DIKATAT	1	SEPTEMBER	2022			
DIPERIKSA	20	SEPTEMBER	2022			
DISETUJUI / DISAHKAN						
DI	SEMARANG					
TGL.	BLN.	THN.	24 SEPTEMBER 2022			
OLEH	ALI HUDA, S.T., M.T.					



KONSTRUKSI DAN FOTO

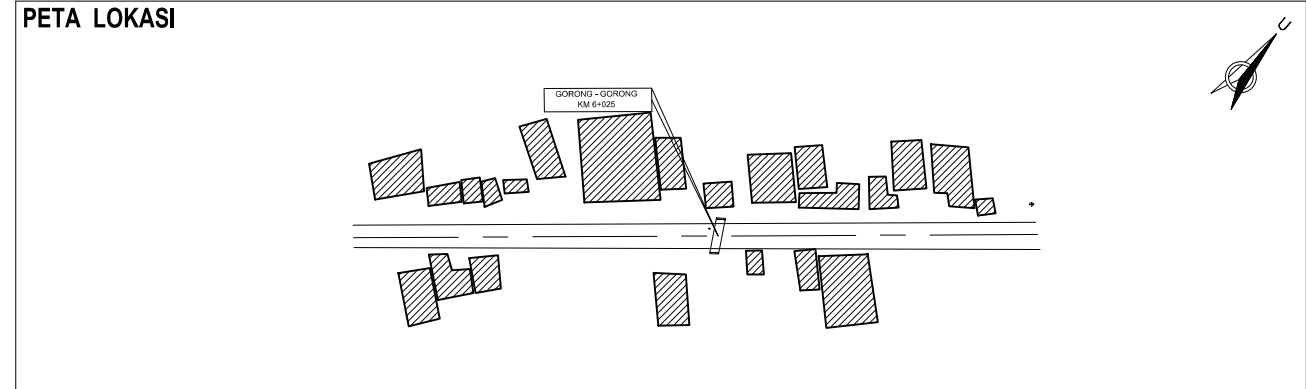
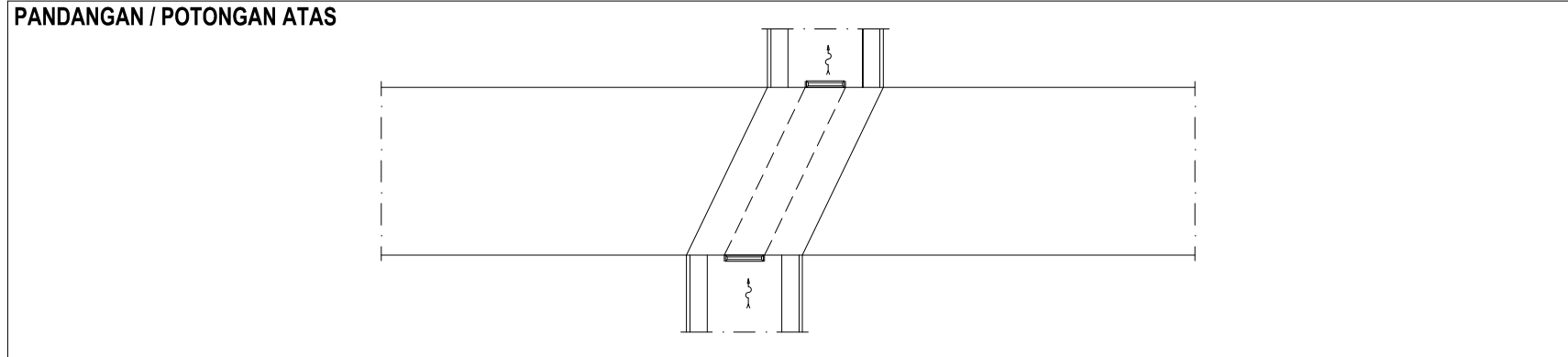
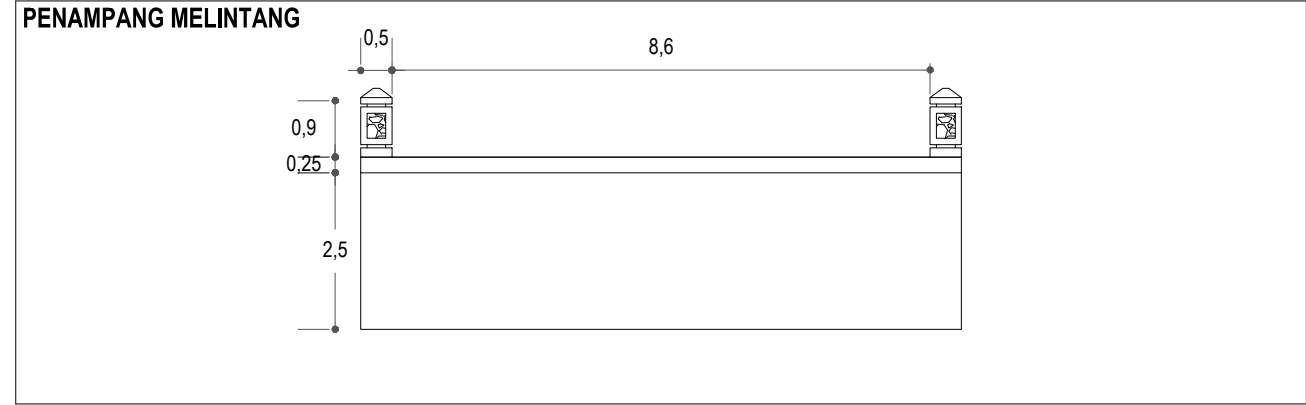

KONDISI UMUM - 2

KEGIATAN POKOK	ASAL / TAHUN : 2022				PEMUTAKHIRAN I / TAHUN :				PEMUTAKHIRAN II / TAHUN :				PEMUTAKHIRAN III / TAHUN :				PEMUTAKHIRAN IV / TAHUN :				PEMUTAKHIRAN V / TAHUN :			
	PELAKSANA	CACAH	BIAYA Rp. 10 ³	SUMBER DANA	PELAKSANA	CACAH	BIAYA Rp. 10 ³	SUMBER DANA	PELAKSANA	CACAH	BIAYA Rp. 10 ³	SUMBER DANA	PELAKSANA	CACAH	BIAYA Rp. 10 ³	SUMBER DANA	PELAKSANA	CACAH	BIAYA Rp. 10 ³	SUMBER DANA	PELAKSANA	CACAH	BIAYA Rp. 10 ³	SUMBER DANA
1. DESAIN																								
2. PEMBEBASAN LAHAN																								
3. PEMBANGUNAN																								
4. PENGANTIAN																								
5. PENINGKATAN																								
6. PENUNJANG																								
7. PEMELIHARAAN & REHAB.																								
8. PEMELIHARAAN BERKALA																								
9. SUPERVISI																								
	JUMLAH				JUMLAH				JUMLAH				JUMLAH				JUMLAH							

RIWAYAT

TGL	BLN	TH.	MACAM KERUSAKAN	PEROLEHAN DATA		SEBAB KERUSAKAN	TGL	BLN	TH.	URAIAN	SIFAT	CACAH	BIAYA	PARAF
				TGL	BLN	TH.								

REFERENSI

NO.	URAIAN	TGL	BLN	TH.	OLEH	PARAF
1	LALU LINTAS					
2	LONGSORAN					
3	GETARAN					
4	ALIRAN SUNGAI					
5	GEOLOGI					
6	PENY. TANAH					
7	FINAL REPORT					
8	KALENDERING					
9	STUDI KELAYAKAN					
10	SURVEI KONDISI					
11	AS BUILD DRAWING					

CATATAN KHUSUS

--

LEGALISASI

KEGIATAN	ASAL 2012		PEMUTAKHIRAN I		PEMUTAKHIRAN II	
	TGL.	BLN.	THN.	TGL.	BLN.	THN.
DIUKUR	25	JULI	2022			
DIGAMBAR	8	AGUSTUS	2022			
DIKATAT	1	SEPTEMBER	2022			
DIPERIKSA	20	SEPTEMBER	2022			
DISETUJUI / DISAHKAN	SEMARANG		SEMARANG		SEMARANG	
DI	24		24		24	
TGL. BLN. THN.	SEPTEMBER		SEPTEMBER		SEPTEMBER	
OLEH	ALI HUDA, S.T., M.T.		ALI HUDA, S.T., M.T.		ALI HUDA, S.T., M.T.	