

# KONSTRUKSI DAN FOTO

## PENAMPANG MEMANJANG

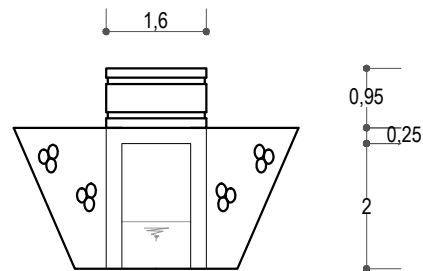

## PENAMPANG MELINTANG

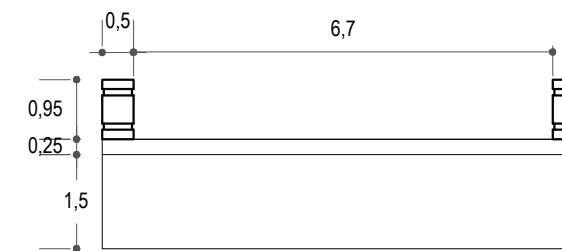

## PANDANGAN / POTONGAN ATAS

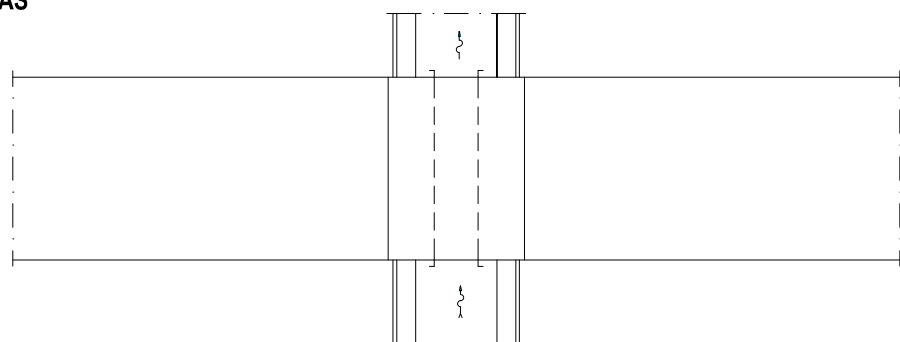

## PETA LOKASI

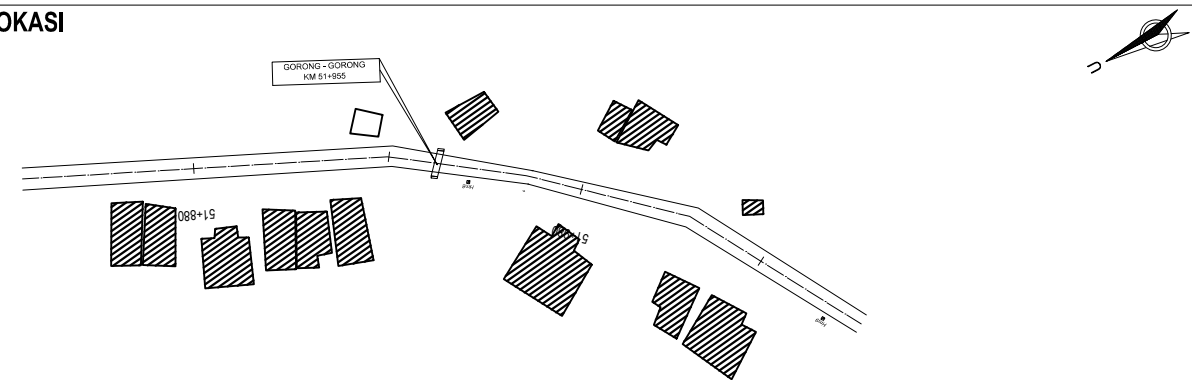

## FOTO PANDANGAN SAMPING DARI HULU / HILIR

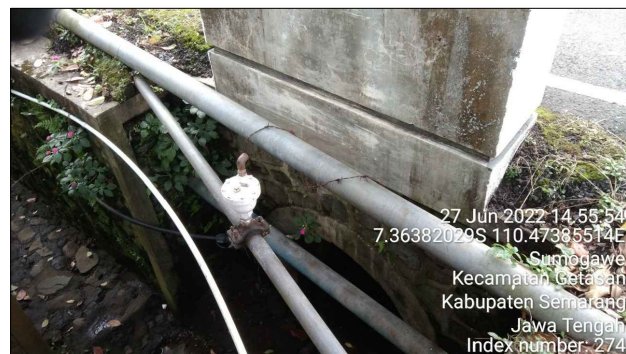

## FOTO JALAN PANDANGAN DEPAN GORONG - GORONG



## KONDISI UMUM - 2

KEGIATAN POKOK	ASAL / TAHUN : 2012				PEMUTAKHIRAN I / TAHUN :				PEMUTAKHIRAN II / TAHUN :				PEMUTAKHIRAN III / TAHUN :				PEMUTAKHIRAN IV / TAHUN :				PEMUTAKHIRAN V / TAHUN :				
	PELAKSANA	CACAH	BIAYA Rp. 10 <sup>3</sup>	SUMBER DANA	PELAKSANA	CACAH	BIAYA Rp. 10 <sup>3</sup>	SUMBER DANA	PELAKSANA	CACAH	BIAYA Rp. 10 <sup>3</sup>	SUMBER DANA	PELAKSANA	CACAH	BIAYA Rp. 10 <sup>3</sup>	SUMBER DANA	PELAKSANA	CACAH	BIAYA Rp. 10 <sup>3</sup>	SUMBER DANA	PELAKSANA	CACAH	BIAYA Rp. 10 <sup>3</sup>	SUMBER DANA	
1. DESAIN																									
2. PEMBEBASAN LAHAN																									
3. PEMBANGUNAN																									
4. PENGANTIAN																									
5. PENINGKATAN																									
6. PENUNJANG																									
7. PEMELIHARAAN & REHAB.																									
8. PEMELIHARAAN BERKALA																									
9. SUPERVISI																									
	JUMLAH				JUMLAH				JUMLAH				JUMLAH				JUMLAH								

## RIWAYAT

TGL	BLN	TH.	MACAM KERUSAKAN	PEROLEHAN DATA		SEBAB KERUSAKAN	TGL	BLN	TH.	URAIAN	SIFAT	CACAH	BIAYA	PARAF
				TGL	BLN	TH.								

## REFERENSI

NO.	URAIAN	TGL	BLN	TH.	OLEH	PARAF
1	LALU LINTAS					
2	LONGSORAN					
3	GETARAN					
4	ALIRAN SUNGAI					
5	GEOLOGI					
6	PENY. TANAH					
7	FINAL REPORT					
8	KALENDERING					
9	STUDI KELAYAKAN					
10	SURVEI KONDISI					
11	AS BUILD DRAWING					

## CATATAN KHUSUS

--

## LEGALISASI

KEGIATAN	ASAL 2012		PEMUTAKHIRAN I		PEMUTAKHIRAN II	
	TGL.	BLN.	THN.	TGL.	BLN.	THN.
DIUKUR	25	JULI	2022			
DIGAMBAR	8	AGUSTUS	2022			
DICATAT	1	SEPTEMBER	2022			
DIPERIKSA	20	SEPTEMBER	2022			
DISETUJUI / DISAHKAN	SEMARANG		SEMARANG		SEMARANG	
DI	TGL. BLN. THN.		TGL. BLN. THN.		TGL. BLN. THN.	
OLEH	ALU HUDA, S.T., M.T.		ALU HUDA, S.T., M.T.		ALU HUDA, S.T., M.T.	

# KONSTRUKSI DAN FOTO

## PENAMPANG MEMANJANG

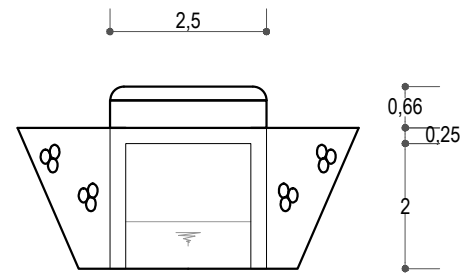

## PENAMPANG MELINTANG

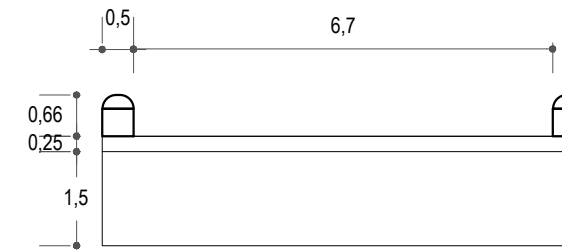

## PANDANGAN / POTONGAN ATAS

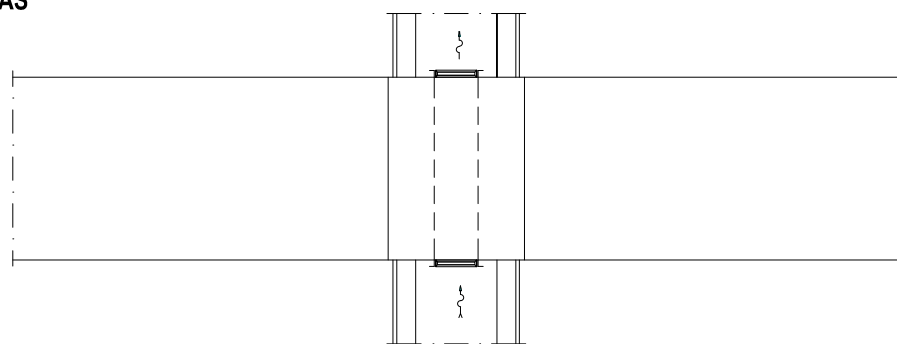

## PETA LOKASI

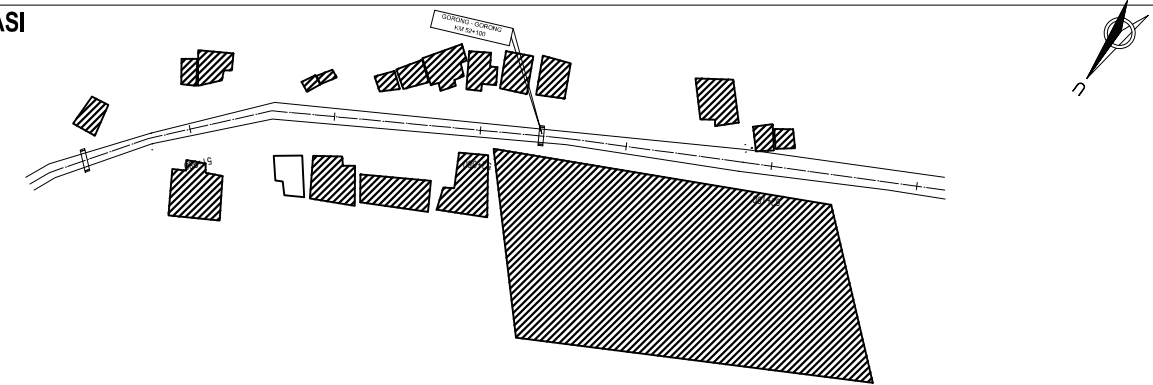

## FOTO PANDANGAN SAMPING DARI HULU / HILIR



## FOTO JALAN PANDANGAN DEPAN GORONG - GORONG



## KONDISI UMUM - 2

KEGIATAN POKOK	ASAL / TAHUN : 2012				PEMUTAKHIRAN I / TAHUN :				PEMUTAKHIRAN II / TAHUN :				PEMUTAKHIRAN III / TAHUN :				PEMUTAKHIRAN IV / TAHUN :				PEMUTAKHIRAN V / TAHUN :				
	PELAKSANA	CACAH	BIAYA Rp. 10 <sup>3</sup>	SUMBER DANA	PELAKSANA	CACAH	BIAYA Rp. 10 <sup>3</sup>	SUMBER DANA	PELAKSANA	CACAH	BIAYA Rp. 10 <sup>3</sup>	SUMBER DANA	PELAKSANA	CACAH	BIAYA Rp. 10 <sup>3</sup>	SUMBER DANA	PELAKSANA	CACAH	BIAYA Rp. 10 <sup>3</sup>	SUMBER DANA	PELAKSANA	CACAH	BIAYA Rp. 10 <sup>3</sup>	SUMBER DANA	
1. DESAIN																									
2. PEMBEBASAN LAHAN																									
3. PEMBANGUNAN																									
4. PENGANTIAN																									
5. PENINGKATAN																									
6. PENUNJANG																									
7. PEMELIHARAAN & REHAB.																									
8. PEMELIHARAAN BERKALA																									
9. SUPERVISI																									
	JUMLAH				JUMLAH				JUMLAH				JUMLAH				JUMLAH								

## RIWAYAT

TGL	BLN	TH.	MACAM KERUSAKAN	PEROLEHAN DATA		SEBAB KERUSAKAN	TGL	BLN	TH.	URAIAN	SIFAT	CACAH	BIAYA	PARAF
				TGL	BLN	TH.								

## REFERENSI

NO.	URAIAN	TGL	BLN	TH.	OLEH	PARAF
1	LALU LINTAS					
2	LONGSORAN					
3	GETARAN					
4	ALIRAN SUNGAI					
5	GEOLOGI					
6	PENY. TANAH					
7	FINAL REPORT					
8	KALENDERING					
9	STUDI KELAYAKAN					
10	SURVEI KONDISI					
11	AS BUILD DRAWING					

## CATATAN KHUSUS

--

## LEGALISASI

KEGIATAN	ASAL 2012		PEMUTAKHIRAN I		PEMUTAKHIRAN II	
	TGL.	BLN.	THN.	TGL.	BLN.	THN.
DIUKUR	25	JULI	2022			
DIGAMBAR	8	AGUSTUS	2022			
DICATAT	1	SEPTEMBER	2022			
DIPERIKSA	20	SEPTEMBER	2022			
DISETUJUI / DISAHKAN	SEMARANG		SEMARANG		SEMARANG	
DI	24		24		24	
TGL. BLN. THN.	SEPTEMBER 2022		SEPTEMBER 2022		SEPTEMBER 2022	
OLEH	ALU HUDA, S.T., M.T.		ALU HUDA, S.T., M.T.		ALU HUDA, S.T., M.T.	

# KONSTRUKSI DAN FOTO

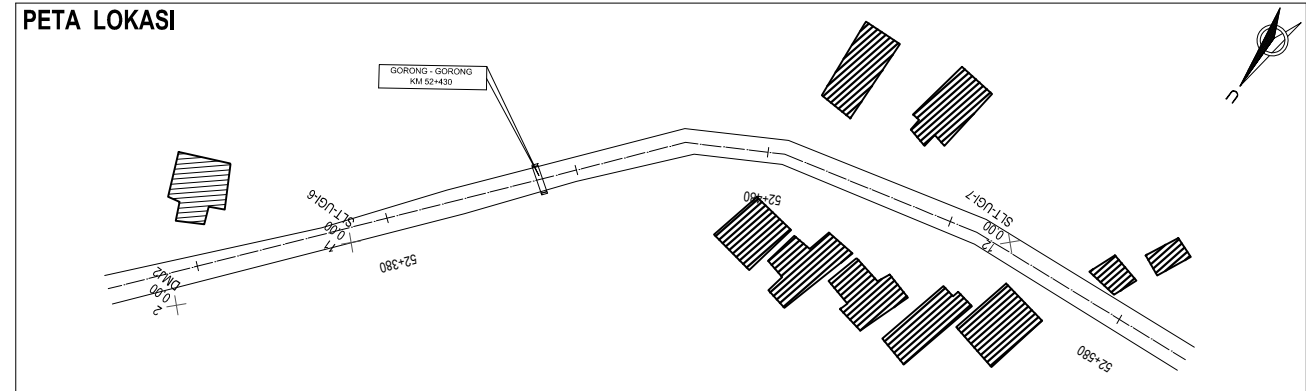
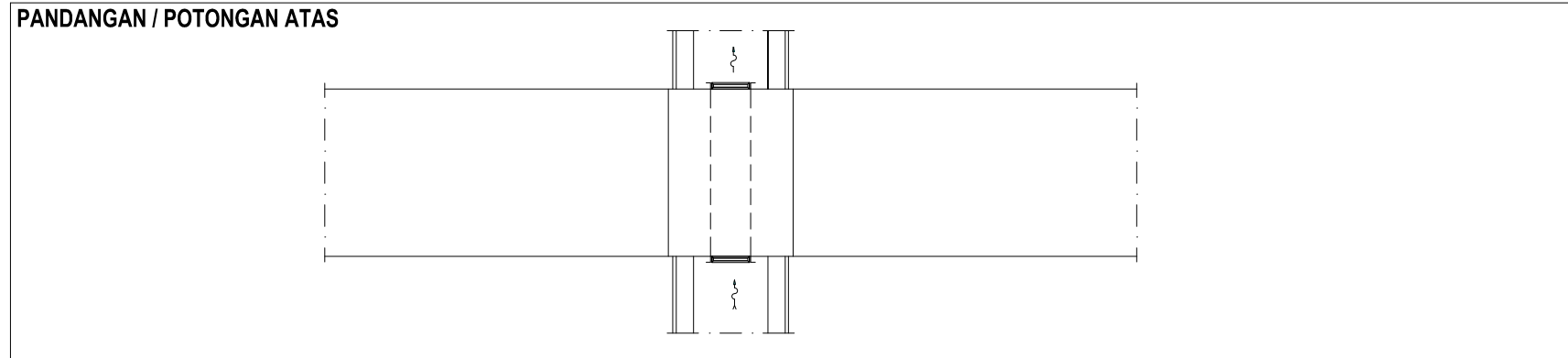
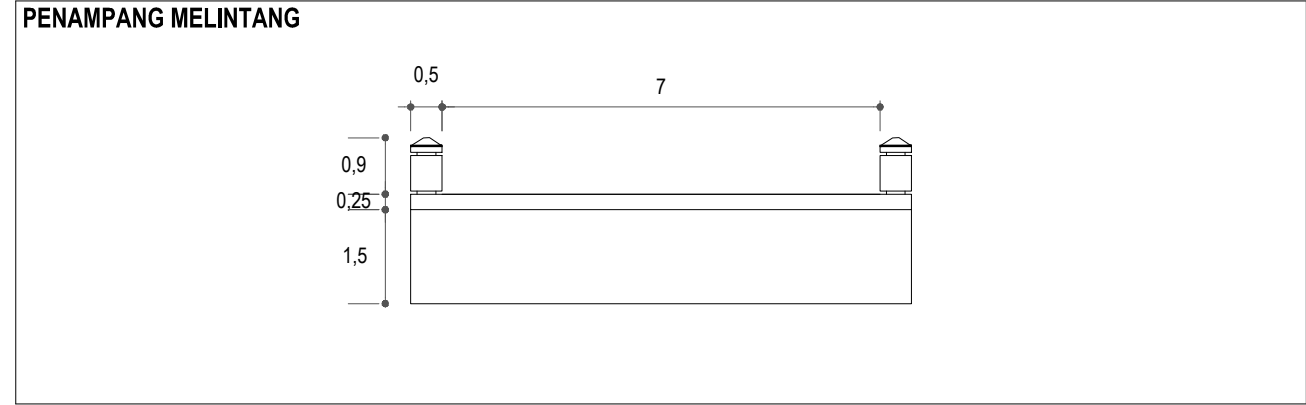

**KONDISI UMUM - 2**

KEGIATAN POKOK	ASAL / TAHUN : 2012				PEMUTAKHIRAN I / TAHUN :				PEMUTAKHIRAN II / TAHUN :				PEMUTAKHIRAN III / TAHUN :				PEMUTAKHIRAN IV / TAHUN :				PEMUTAKHIRAN V / TAHUN :				
	PELAKSANA	CACAH	BIAYA Rp. 10 <sup>3</sup>	SUMBER DANA	PELAKSANA	CACAH	BIAYA Rp. 10 <sup>3</sup>	SUMBER DANA	PELAKSANA	CACAH	BIAYA Rp. 10 <sup>3</sup>	SUMBER DANA	PELAKSANA	CACAH	BIAYA Rp. 10 <sup>3</sup>	SUMBER DANA	PELAKSANA	CACAH	BIAYA Rp. 10 <sup>3</sup>	SUMBER DANA	PELAKSANA	CACAH	BIAYA Rp. 10 <sup>3</sup>	SUMBER DANA	
1. DESAIN																									
2. PEMBEBASAN LAHAN																									
3. PEMBANGUNAN																									
4. PENGANTIAN																									
5. PENINGKATAN																									
6. PENUNJANG																									
7. PEMELIHARAAN & REHAB.																									
8. PEMELIHARAAN BERKALA																									
9. SUPERVISI																									
	JUMLAH				JUMLAH				JUMLAH				JUMLAH				JUMLAH								

**RIWAYAT**

TGL	BLN	TH.	MACAM KERUSAKAN	PEROLEHAN DATA		SEBAB KERUSAKAN	TGL	BLN	TH.	URAIAN	SIFAT	CACAH	BIAYA	PARAF
				TGL	BLN	TH.								

**REFERENSI**

NO.	URAIAN	TGL	BLN	TH.	OLEH	PARAF
1	LALU LINTAS					
2	LONGSORAN					
3	GETARAN					
4	ALIRAN SUNGAI					
5	GEOLOGI					
6	PENY. TANAH					
7	FINAL REPORT					
8	KALENDERING					
9	STUDI KELAYAKAN					
10	SURVEI KONDISI					
11	AS BUILD DRAWING					

**CATATAN KHUSUS**

--

**LEGALISASI**

KEGIATAN	ASAL 2012		PEMUTAKHIRAN I		PEMUTAKHIRAN II	
	TGL.	BLN.	THN.	TGL.	BLN.	THN.
DIUKUR	25	JULI	2022			
DIGAMBAR	8	AGUSTUS	2022			
DICATAT	1	SEPTEMBER	2022			
DIPERIKSA	20	SEPTEMBER	2022			
DISETUJUI / DISAHKAN	SEMARANG					
DI	24					
TGL. BLN. THN.	24					
OLEH	ALU HUDA, S.T., M.T.					

# KONSTRUKSI DAN FOTO

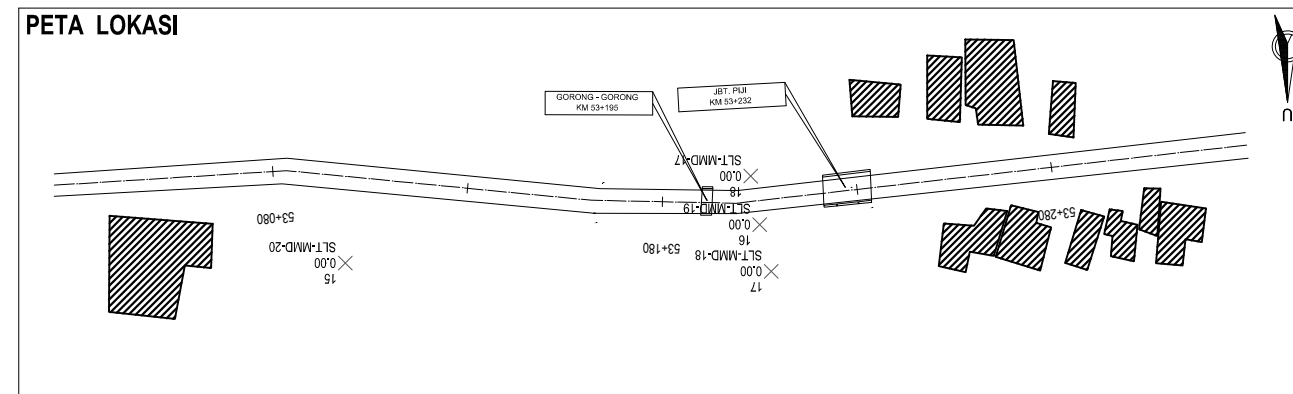
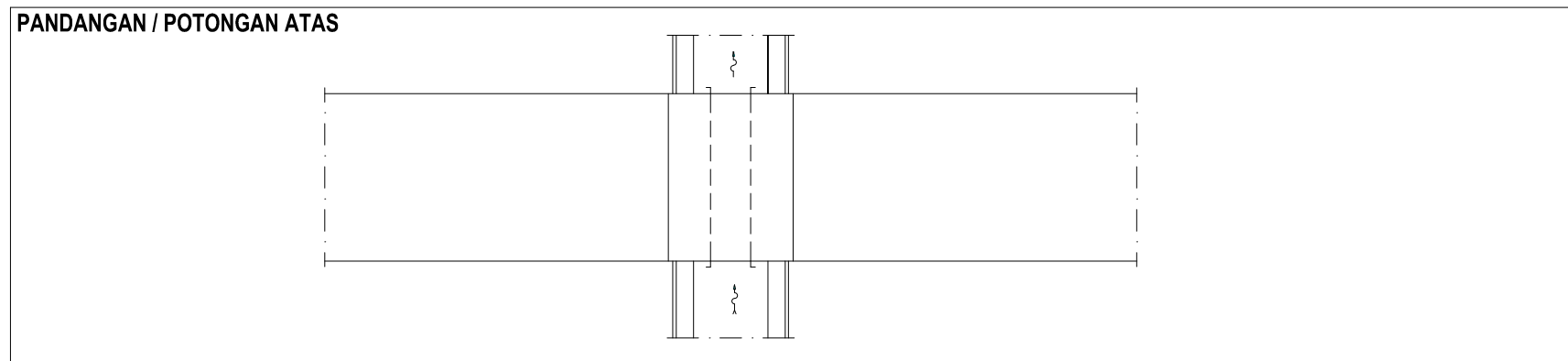
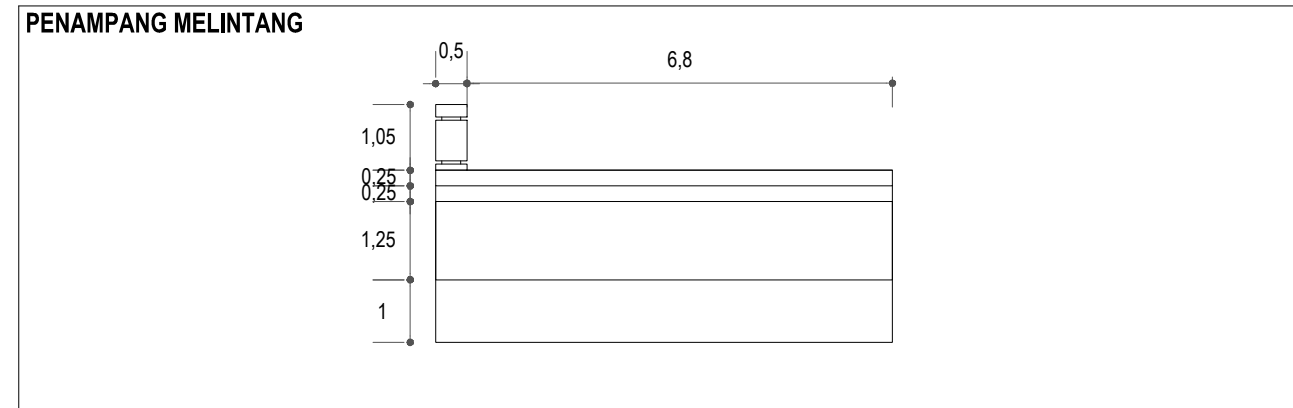
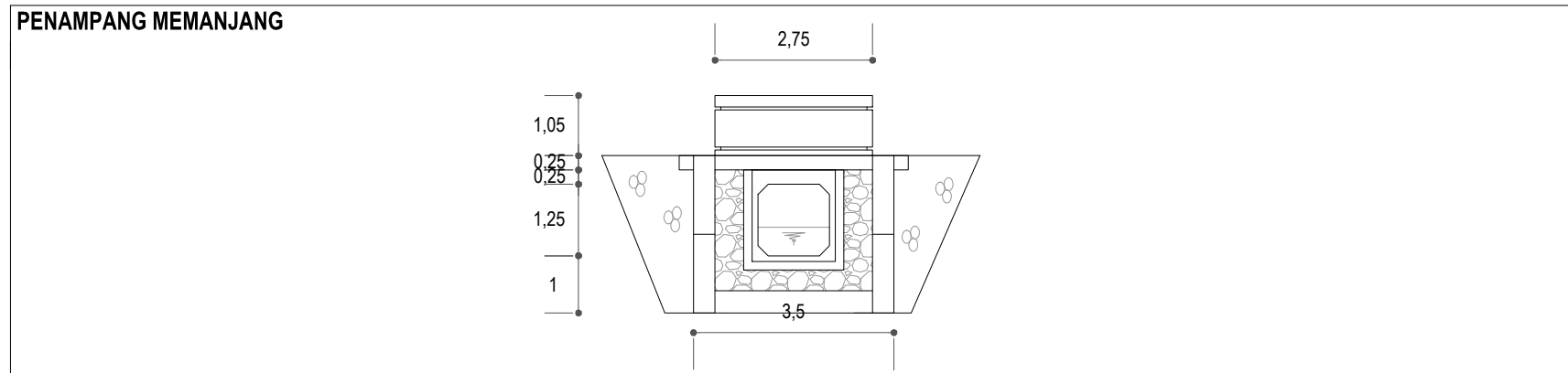

**KONDISI UMUM - 2**

KEGIATAN POKOK	ASAL / TAHUN : 2012				PEMUTAKHIRAN I / TAHUN :				PEMUTAKHIRAN II / TAHUN :				PEMUTAKHIRAN III / TAHUN :				PEMUTAKHIRAN IV / TAHUN :				PEMUTAKHIRAN V / TAHUN :				
	PELAKSANA	CACAH	BIAYA Rp. 10 <sup>3</sup>	SUMBER DANA	PELAKSANA	CACAH	BIAYA Rp. 10 <sup>3</sup>	SUMBER DANA	PELAKSANA	CACAH	BIAYA Rp. 10 <sup>3</sup>	SUMBER DANA	PELAKSANA	CACAH	BIAYA Rp. 10 <sup>3</sup>	SUMBER DANA	PELAKSANA	CACAH	BIAYA Rp. 10 <sup>3</sup>	SUMBER DANA	PELAKSANA	CACAH	BIAYA Rp. 10 <sup>3</sup>	SUMBER DANA	
1. DESAIN																									
2. PEMBEBASAN LAHAN																									
3. PEMBANGUNAN																									
4. PENGANTIAN																									
5. PENINGKATAN																									
6. PENUNJANG																									
7. PEMELIHARAAN & REHAB.																									
8. PEMELIHARAAN BERKALA																									
9. SUPERVISI																									
	JUMLAH				JUMLAH				JUMLAH				JUMLAH				JUMLAH								

**RIWAYAT**

TGL	BLN	TH.	MACAM KERUSAKAN	PEROLEHAN DATA		SEBAB KERUSAKAN	TGL	BLN	TH.	URAIAN	SIFAT	CACAH	BIAYA	PARAF
				TGL	BLN	TH.								

**REFERENSI**

NO.	URAIAN	TGL	BLN	TH.	OLEH	PARAF
1	LALU LINTAS					
2	LONGSORAN					
3	GETARAN					
4	ALIRAN SUNGAI					
5	GEOLOGI					
6	PENY. TANAH					
7	FINAL REPORT					
8	KALENDERING					
9	STUDI KELAYAKAN					
10	SURVEI KONDISI					
11	AS BUILD DRAWING					

**CATATAN KHUSUS**

--

**LEGALISASI**

KEGIATAN	ASAL 2012		PEMUTAKHIRAN I		PEMUTAKHIRAN II	
	TGL.	BLN.	THN.	TGL.	BLN.	THN.
DIUKUR	25	JULI	2022			
DIGAMBAR	8	AGUSTUS	2022			
DICATAT	1	SEPTEMBER	2022			
DIPERIKSA	20	SEPTEMBER	2022			
DISETUJUI / DISAHKAN						
DI	SEMARANG		SEMARANG		SEMARANG	
TGL. BLN. THN.	24		24		24	
OLEH	ALU HUDA, S.T., M.T.		ALU HUDA, S.T., M.T.		ALU HUDA, S.T., M.T.	

# KONSTRUKSI DAN FOTO

## PENAMPANG MEMANJANG

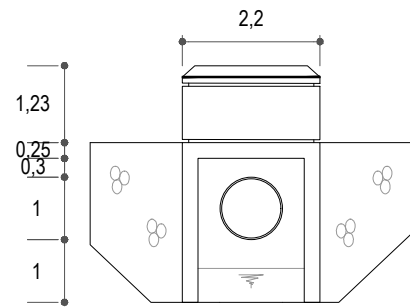

## PENAMPANG MELINTANG

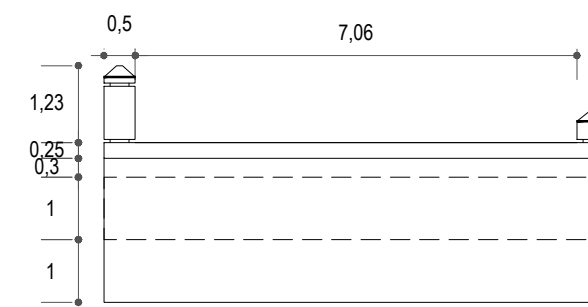

## PANDANGAN / POTONGAN ATAS

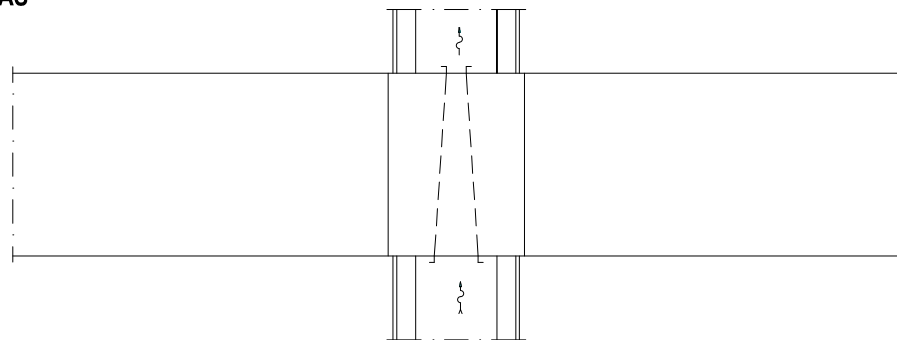

## PETA LOKASI

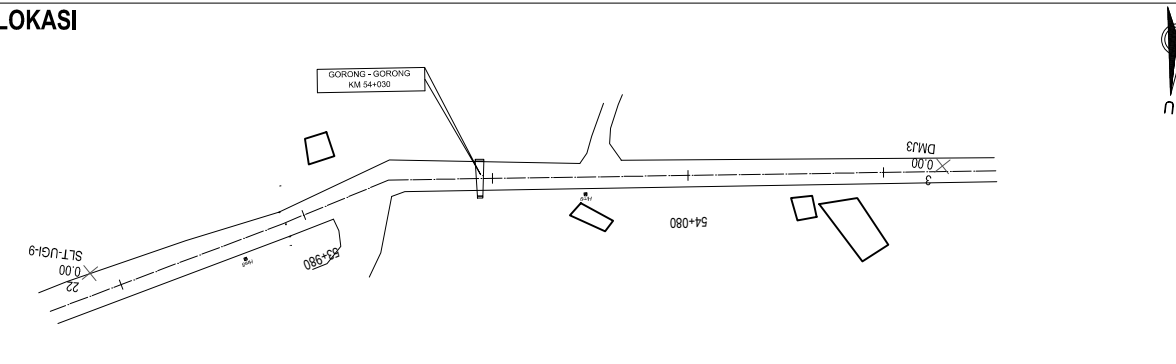

## FOTO PANDANGAN SAMPING DARI HULU / HILIR



## FOTO JALAN PANDANGAN DEPAN GORONG - GORONG



## KONDISI UMUM - 2

KEGIATAN POKOK	ASAL / TAHUN : 2012				PEMUTAKHIRAN I / TAHUN :				PEMUTAKHIRAN II / TAHUN :				PEMUTAKHIRAN III / TAHUN :				PEMUTAKHIRAN IV / TAHUN :				PEMUTAKHIRAN V / TAHUN :				
	PELAKSANA	CACAH	BIAYA Rp. 10 <sup>3</sup>	SUMBER DANA	PELAKSANA	CACAH	BIAYA Rp. 10 <sup>3</sup>	SUMBER DANA	PELAKSANA	CACAH	BIAYA Rp. 10 <sup>3</sup>	SUMBER DANA	PELAKSANA	CACAH	BIAYA Rp. 10 <sup>3</sup>	SUMBER DANA	PELAKSANA	CACAH	BIAYA Rp. 10 <sup>3</sup>	SUMBER DANA	PELAKSANA	CACAH	BIAYA Rp. 10 <sup>3</sup>	SUMBER DANA	
1. DESAIN																									
2. PEMBEBASAN LAHAN																									
3. PEMBANGUNAN																									
4. PENGANTIAN																									
5. PENINGKATAN																									
6. PENUNJANG																									
7. PEMELIHARAAN & REHAB.																									
8. PEMELIHARAAN BERKALA																									
9. SUPERVISI																									
	JUMLAH				JUMLAH				JUMLAH				JUMLAH				JUMLAH								

## RIWAYAT

TGL	BLN	TH.	MACAM KERUSAKAN	PEROLEHAN DATA		SEBAB KERUSAKAN	TGL	BLN	TH.	URAIAN	SIFAT	CACAH	BIAYA	PARAF
				TGL	BLN	TH.								

## REFERENSI

NO.	URAIAN	TGL	BLN	TH.	OLEH	PARAF
1	LALU LINTAS					
2	LONGSORAN					
3	GETARAN					
4	ALIRAN SUNGAI					
5	GEOLOGI					
6	PENY. TANAH					
7	FINAL REPORT					
8	KALENDERING					
9	STUDI KELAYAKAN					
10	SURVEI KONDISI					
11	AS BUILD DRAWING					

## CATATAN KHUSUS

--

## LEGALISASI

KEGIATAN	ASAL 2012		PEMUTAKHIRAN I		PEMUTAKHIRAN II	
	TGL.	BLN.	THN.	TGL.	BLN.	THN.
DIUKUR	25	JULI	2022			
DIGAMBAR	8	AGUSTUS	2022			
DICATAT	1	SEPTEMBER	2022			
DIPERIKSA	20	SEPTEMBER	2022			
DISETUJUI / DISAHKAN	SEMARANG		SEMARANG		SEMARANG	
DI	TGL. BLN. THN.		TGL. BLN. THN.		TGL. BLN. THN.	
OLEH	ALU HUDA, S.T., M.T.		ALU HUDA, S.T., M.T.		ALU HUDA, S.T., M.T.	